

ANIMADIBAGNO

Colección baños · Bath collection



Bienvenido / Welcome.

Somos profesionales del sector desde hace más de 30 años.

Dedicados en exclusiva al concepto del mueble.

Nuestra línea de muebles y accesorios combina la tradición, dedicación y desarrollo que en conjunto con todo el grupo de profesionales que forman nuestra marca hacen que podamos hacer realidad un producto de alta calidad para poder satisfacer las necesidades de todos nuestros clientes.

We have been professionals in the sector for more than 30 years.

Dedicated exclusively to the concept of furniture.

Our line of bathrooms combines tradition, dedication and development that together with the entire group of professionals that make up our brand They make it possible for us to make a high-quality product a reality in order to satisfy the needs of all our clients.

ANIMADIBAGNO

Colección baños · Bath collection



4 Adapta



12 Marko lacado



18 Balma



30 Gaire



81 Imagina ingletado



85 Imagina manhatan



89 Imagina ingletado



93 Imagina paris



36 Alpe



42 Marko madera



47 Mini



51 Horizon



97 Imagina Jey



101 Imagina Push



55 Quatro



59 Modulate susp.



61 Toomuch



63 Toomuch plus



65 Floop



67 Floop plus

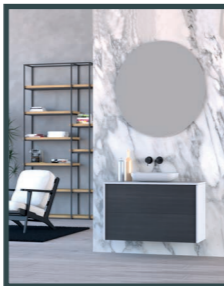

69 Tiles



73 Manhattan

105/108 **Materiales** Materials

109/112 **Solid surface** 10

113/116 **Solid surface** 1,2

117/126 **Lavabos** sink

127/134 **Espejos y iluminación de espejos** Mirrors and mirror lighting

135/136 **Iluminación** Lightness

137/140 **Estanterías** Shelves

141/144 **Modulos decorativos** Decorative modules

145 **Encimera tipo C** C-type countertop

146 **Patas y escuadras** Legs and brackets

147 **Tapas sobre mueble** Covers on furniture

148 **Estante oculto** Hidden shelf

149 **Encimera 2 cm carga mineral.** Countertop 2 cm

150 **Toalleros** towel rails

151/152 **Organizador** Organizer

153/154 **Herrajes** Hardware



Adapta.

Un diseño formado por dos cajones acompañados de un fino tirador que juega con el cambio de tamaño entre ambos tiradores, consiguiendo dar un carácter muy personal al diseño del mueble.

Sencillo y práctico, atributos que, sumados a su amplia variedad de combinaciones entre los materiales del frente y los colores del tirador, hacen de este mueble la opción más versátil, ofreciendo una gran posibilidad de integración en muy diferentes espacios.

A design made up of two drawers accompanied by a fine handle that plays with the change in size between both handles, managing to give a very personal character to the design of the furniture.

Simple and practical, attributes that, added to its wide variety of combinations between front materials and the colors of the handle, make this piece of furniture the most versatile option, offering a great possibility of integration in very different spaces.

Adapta

Composición modelo Adapta 90, material laminado blanco acabado mate, tirador acabado en negro mate.

Lavabo cerámico encastrado THIN de 91 cm.
Espejo redondo con marco negro de 80 cm de circunferencia.

Composition of the Adapta 90 model, matt finish white laminate material, matt black finish handle
THIN 91 cm built-in ceramic washbasin.
Round mirror with black frame, 80 cm in circumference



Adapta

Composición modelo Adapta 120, material lacado mate RAL personalizado azul pastel REF. R 153 G 176 B 170, tirador acabado en blanco mate. Lavabo SOLID SURFACE de 120 de 1,2 cm de grosor. Espejo ESSENTIAL 80x100 cm.

Composition of the Adapta 120 model, RAL matt lacquered material customized pastel blue REF. R 153 G 176 B 170, handle finished in matt white. SOLID SURFACE 120 washbasin, 12 cm thick. ESSENTIAL mirror 80x100 cm.

Medidas / Measures

| CÓDIGO MUEBLE FURNITURE CODE | CÓDIGO LACA LACQUER CODE | CÓDIGO LAMINADO LAMINATED CODE | CÓDIGO FANTASIA FANTASIE CODE | CÓDIGO TIRADOR HANDLE CODE |
|---------------------------------|-----------------------------|-----------------------------------|----------------------------------|-------------------------------|
|---------------------------------|-----------------------------|-----------------------------------|----------------------------------|-------------------------------|

60 cm (60 x 45 x 60)

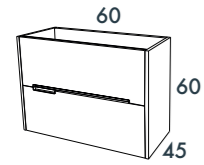

ADAP 6080

LACA+(COLOR.)

LAM+(MATERIAL.)

FANT+(MATERIAL.)

TIR+(COLOR.)

80 cm (80 x 45 x 60)

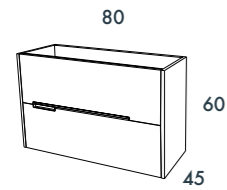

ADAP 6080

LACA+(COLOR.)

LAM+(MATERIAL.)

FANT+(MATERIAL.)

TIR+(COLOR.)

90 cm (90 x 45 x 60)

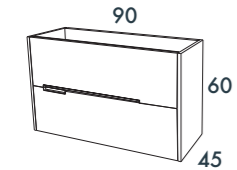

ADAP 6090

LACA+(COLOR.)

LAM+(MATERIAL.)

FANT+(MATERIAL.)

TIR+(COLOR.)

100 cm (100 x 45 x 60)

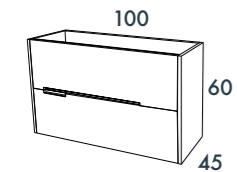

ADAP 60100

LACA+(COLOR.)

LAM+(MATERIAL.)

FANT+(MATERIAL.)

TIR+(COLOR.)

120 cm (120 x 45 x 60)

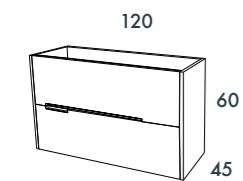

ADAP 60120

LACA+(COLOR.)

LAM+(MATERIAL.)

FANT+(MATERIAL.)

TIR+(COLOR.)

EJEMPLO DE CODIFICACIÓN PARA PEDIDO EXAMPLE OF CODING FOR ORDER

MUEBLE DE 120 ACABADO EN LACA OCEAN TIRADOR NEGRO MATE
FURNITURE OF 120 LACQUERED OCEAN FINISHES MATTE BLACK HANDLESS

ADAP60120 / LACA OCEAN / TIRNEGRO

Acabados / Finishes.

LACADO MATE / LAQUERED.



1.- Blanco. 2.- Beige. 3.- Arena. 4.- Sepia. 5.- Burdeos. 6.- Oceano. 7.- Marengo. 8.- Negro. 9.- Vison. 10.- Gris. 11.- Malen. 12.- Verdone. 13.- Azul. RAL

*COLOR RAL incremento de un 25% segun tarifa.

LAMINADOS / LAMINATES



1.- Blanco. 2.- Halifax. 3.- Nogal tostado. 4.- Trufa. 5.- Roble welles. 6.- Navarra arena. 7.- Nudo. 8.- Zayan. 9.- Chester. 10.- Hickory. 11.- Ulmus.

FANTASIAS / FANTASIES



1.- Bottega. 2.- Riga. 3.- Vulcano. 4.- Line.

Colores tirador / Handle colours.

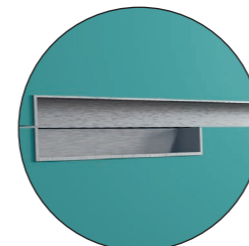

BLANCO MATE.

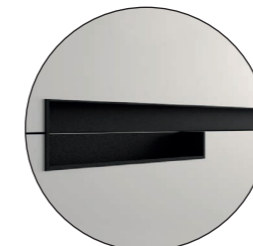

NEGRO MATE.

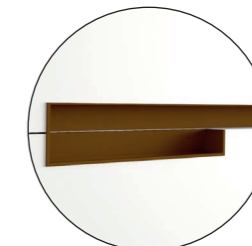

MARRÓN METALIZADO.

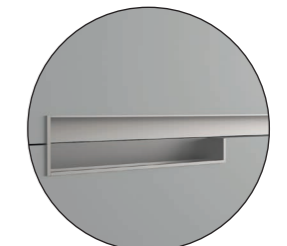

GRIS METALIZADO.

Lavabos admitidos / supported sinks

· LAVABO DE ENCASTRE · SOBRE ENCIMERA (EN ESTE CASO AÑADIR TAPA SOBRE MUEBLE) · ADMITE FONDO REDUCIDO 38,5 SIN SOBRE COSTE.

· BUILT-IN WASHBASIN · OVER COUNTERTOP (IN THIS CASE, ADD A COVER OVER FURNITURE) · ADMITS REDUCED DEPTH 38.5 WITHOUT ADDITIONAL COST.

* INDICAR SI ES PORTALAVABO

· INDICATE IF IT IS A BASIN HOLDER



MarkoLacado.

Un diseño atemporal que lo definen su líneas rectas. Compuesto por un tirador fino y estilizado en forma de cuña, instalado en un frente con un marco que consta de un suave perfil, hacen de este mueble un diseño que parece estar congelado en el tiempo.

A timeless design that is defined by its straight lines. Composed of a thin and stylized wedge-shaped handle, installed on a front with a frame that consists of a smooth profile, they make this piece of furniture a design that seems to be frozen in time.



MarkoLacado.
2 Módulos de un cajón de 60. Color Ocean.
Lavabo Agatha de 120 seno desplazado izquierda.
Espejo Elegance marco negro 40x100.
2 Modules of a drawer of 60. Color Ocean.
Agatha washbasin 120 left offset bowl.
Mirror Elegance 40x100

CÓDIGOS COMPOSICIÓN. · COMPOSITION CODES :
MRKL3060 2 UND. / EL40X100 / LVAGDD12



Medidas / Measures

1 cajón de 60 cm (60 x 45 x 30)

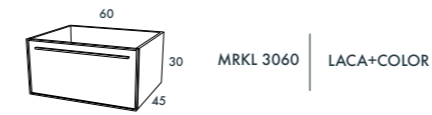

1 cajón de 70 cm (70 x 45 x 30)



1 cajón de 80 cm (80 x 45 x 30)



1 cajón de 90 cm (90 x 45 x 30)

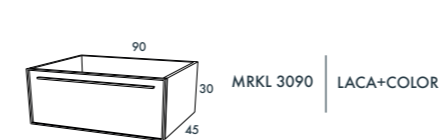

1 cajón de 100 cm (100 x 45 x 30)

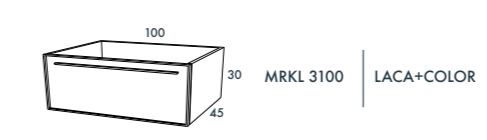

1 cajón de 120 cm (120 x 45 x 30)

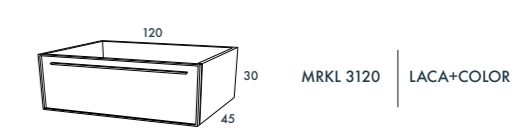

1 cajón con cajón interior de 60 cm (60 x 45 x 45)

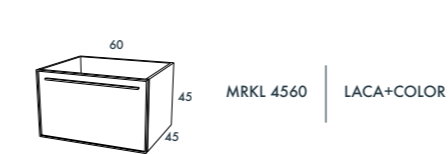

1 cajón con cajón interior de 70 cm (70 x 45 x 45)

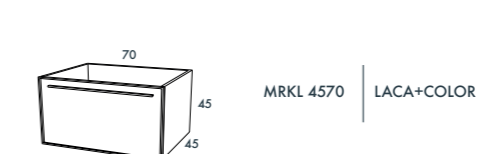

1 cajón con cajón interior de 80 cm (80 x 45 x 45)

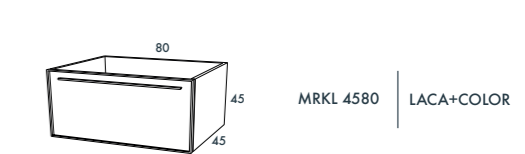

1 cajón con cajón interior de 90 cm (90 x 45 x 45)

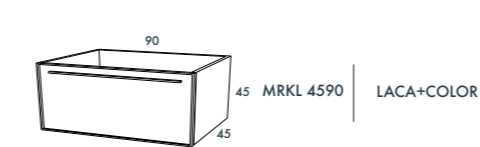

1 cajón con cajón interior de 100 cm (100 x 45 x 45)

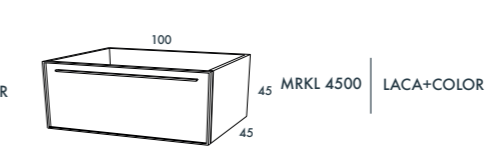

1 cajón con cajón interior de 120 cm (120 x 45 x 45)

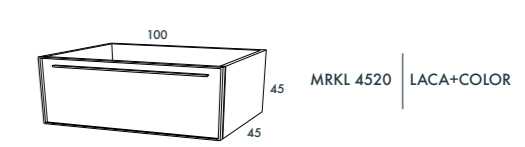

2 cajones de 60 cm (60 x 45 x 60)

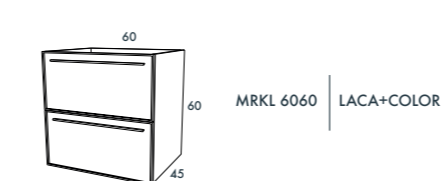

2 cajones de 70 cm (70 x 45 x 60)

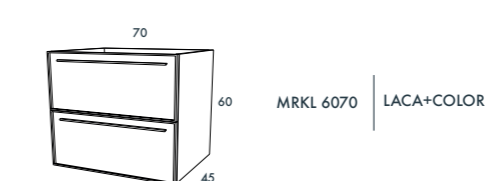

2 cajones de 80 cm (80 x 45 x 60)

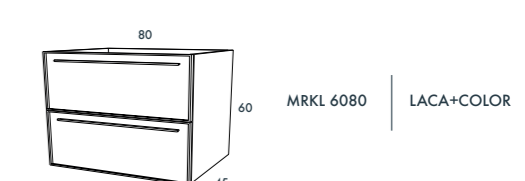

2 cajones de 90 cm (90 x 45 x 60)

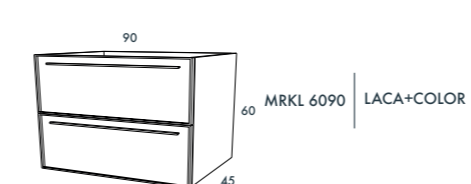

2 cajones de 100 cm (100 x 45 x 60)

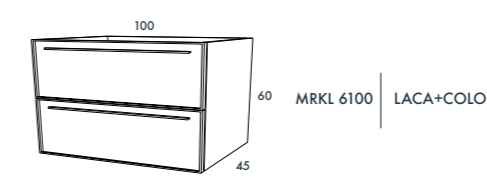

2 cajones de 120 cm (120 x 45 x 60)

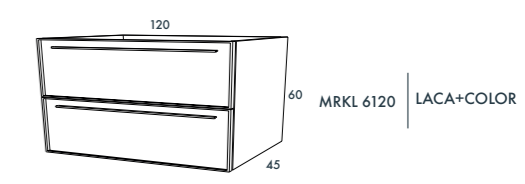

Acabados. LACADOS MATE.

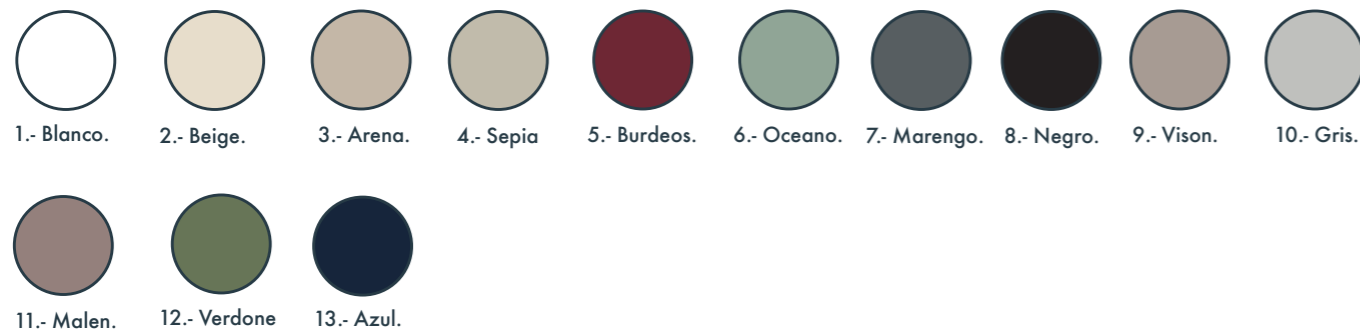

Lavabos admitidos / supported sinks

· LAVABO DE ENCASTRE · SOBRE ENCIMERA (EN ESTE CASO AÑADIR TAPA SOBRE MUEBLE) · ADMITE FONDO REDUCIDO 38,5 SIN SOBRE COSTE.

· BUILT-IN WASHBASIN · OVER COUNTERTOP (IN THIS CASE, ADD A COVER OVER FURNITURE) · ADMITS REDUCED DEPTH 38.5 WITHOUT ADDITIONAL COST.

* INDICAR SI ES PORTALAVABO / INDICATE IF IT IS A BASIN HOLDER.

EJEMPLO DE CODIFICACIÓN PARA PEDIDO. EXAMPLE OF CODING FOR ORDER.

MUEBLE DE 2 CAJONES DE 80 ACABADO LACA SEPIA.

FURNITURE WITH 2 DRAWERS OF 80 SEPIA LACQUER FINISH.

MRKL 6080 / SEPIA.



Balma.

Un mueble sencillo y elegante, mueble realizado en MDF donde se mecaniza en el propio frente el diseño de el cajón y el tirador. Consta de dos opciones de franjas paralelas pudiendo ser horizontales o verticales en la que se acompaña con un tirador central mecanizado en la puerta en forma de asa.

Su sencillez se mezcla con la sofisticación y la elegancia, logrando un mueble que no dejará a nadie indiferente.

A simple and elegant piece of furniture, a piece of furniture made of MDF where the design of the drawer and the handle are machined on the front itself. It consists of two options of parallel strips, which can be horizontal or vertical, in which it is accompanied by a central mechanized handle on the door in the form of a handle.

Its simplicity is mixed with sophistication and elegance, achieving a piece of furniture that will not leave anyone indifferent.

Balma.



Balma.

Modelo Balma 80 franja de 5 cm horizontal.
Acabado blanco mate.
2 espejos redondo de 60 cm. marco blanco.
Tapa sobre mueble de 2 cm de grosor acabado en blanco.
Lavabo Cilin. 2 und.
Balma 80 model 5 cm horizontal strip.
Matte white finish.
2 round mirrors of 60 cm. white frame.
Top on furniture 2 cm thick finished in white.
Cilin washbasin. 2 units

CÓDIGOS COMPOSICIÓN.

BALM6080HORIS X 2UND. / ESRBL060 / LVSS2160

CÓDIGOS COMPOSICIÓN.

BALM6080HORIS X 2UND / ESRBL060 / LVBOCILIN



Balma.

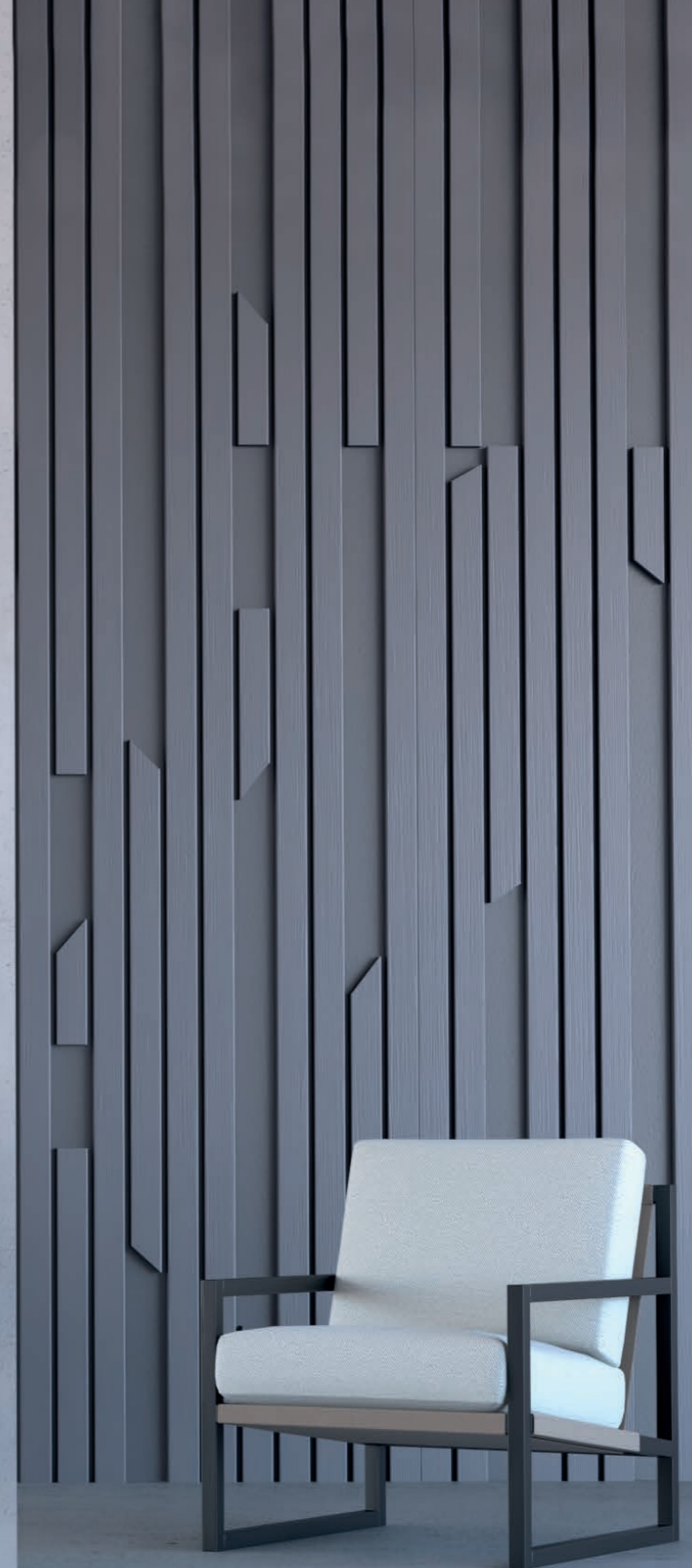

Balma.

Modelo Balma 60 franja vertical de 10 cm. 3 Und.

Material negro mate

Tapa sobre mueble acabado Zayan.

Lavabo Nili negro mate. 2 und.

Balma 60 model 10 cm vertical strip. 3 units

matt black material

Cover on furniture Zayan finish.

Matte black Nili washbasin. 2 units

CÓDIGOS COMPOSICIÓN. · COMPOSITION CODES :

BALM3060VERT10 3 UND / TSMLAM38 / SOPEST 4S / LVNILINM 2 UND.

Balma.

2 muebles Modelo Balma 80 franja vertical de 5 cm.

Acabado Malen.

Tapa sobre mueble de 2 cm acabado Malen.

Espejo Minimal de 80x160 cm.

2 lavabos Furnan acabado blanco mate.

2 furniture Model Balma 80 vertical strip of 5 cm.

Malen finish.

Top on 2 cm furniture, Malen finish.

Minimal mirror 80x160 cm.

2 Furnan sinks matt white finish.

CÓDIGOS COMPOSICIÓN.

BALM3080/VERT/5 2 UND / MI160X080 / TSMLAC22 / LVFURNASB

COMPOSITION CODES

BALM3080 X2 UND. / MI160X080 / TSMLAC22 / LVFURNASB





Balma.

Modelo Balma 30 horizontal de 10 cm. 2 und.
Acabado gris marengo.
Hueco decorativo, tapa sobre mueble gris marengo.
Encimera solid surface de 5 cm de espesor.
Escuadras de sujeción 2 und.
Lavabo iseo.

Balma 30 horizontal model of 10 cm. 2 units
Charcoal gray finish.
Decorative hole, cover on charcoal gray furniture.
5 cm thick solid surface countertop.
Support brackets 2 und.
iseo washbasin

CÓDIGOS COMPOSICIÓN. · COMPOSITION CODES
TAVI3060. / IMDB1360 / MI110X070 / TSMLAC22 /
/ E10CF121/LVOISEO/ESCUADSS

Medidas / Measures

CÓDIGO MUEBLE
FURNITURE CODE

HORIZONTAL/VERTICAL
HORIZONTAL/VERTICAL

CÓDIGO LACA
LACQUER CODE

DISTANCIA ENTRE FRANJAS
DISTANCE BETWEEN STRIPES

1 Cajón de 60 cm (60 x 45 x 30)

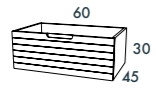

BALM 3060

HORI./VERT.

COLOR

5 cm. / 10 cm.

1 Cajón de 80 cm (80 x 45 x 30)

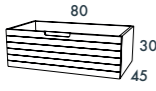

BALM 3080

HORI./VERT.

COLOR

5 cm. / 10 cm.

1 Cajón de 90 cm (90 x 45 x 30)

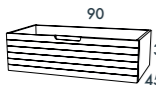

BALM 3090

HORI./VERT.

COLOR

5 cm. / 10 cm.

1 Cajón de 100 cm (100 x 45 x 30)



BALM 3010

HORI./VERT.

COLOR

5 cm. / 10 cm.

1 Cajón de 120 cm (120 x 45 x 30)

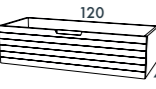

BALM 3012

HORI./VERT.

COLOR

5 cm. / 10 cm.

2 Cajones de 60 cm (60 x 45 x 60)

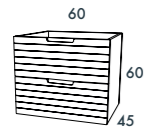

BALM 6060

HORI./VERT.

COLOR

5 cm. / 10 cm.

2 Cajones de 80 cm (80 x 45 x 60)

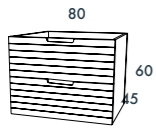

BALM 6080

HORI./VERT.

COLOR

5 cm. / 10 cm.

2 Cajones de 90 cm (90 x 45 x 60)

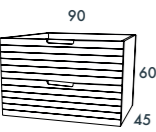

BALM 6090

HORI./VERT.

COLOR

5 cm. / 10 cm.

2 Cajones de 100 cm (100 x 45 x 60)

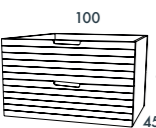

BALM 6100

HORI./VERT.

COLOR

5 cm. / 10 cm.

Medidas / Measures

CÓDIGO MUEBLE
FURNITURE CODE

HORIZONTAL/VERTICAL
HORIZONTAL/VERTICAL

CÓDIGO LACA
LACQUER CODE

DISTANCIA ENTRE FRANJAS
DISTANCE BETWEEN STRIPES

2 Cajones de 120 cm (120 x 45 x 60)

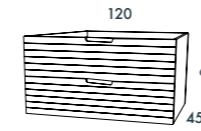

BALM 6120

HORI./VERT.

COLOR

5 cm. / 10 cm.

1 Cajón con cajón interior 60 cm (60 x 45 x 50)

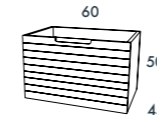

BALM 5060

HORI./VERT.

COLOR

5 cm. / 10 cm.

1 Cajón con cajón interior 80 cm (80 x 45 x 50)

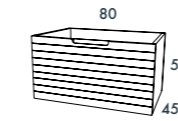

BALM 5080

HORI./VERT.

COLOR

5 cm. / 10 cm.

1 Cajón con cajón interior 100 cm (100 x 45 x 50)

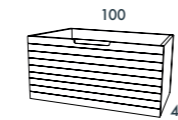

BALM 50100

HORI./VERT.

COLOR

5 cm. / 10 cm.

EJEMPLO DE CODIFICACIÓN PARA PEDIDO EXAMPLE OF CODING FOR ORDER

MUEBLE DE 60 FRANJA HORIZONTAL DE 5CM COLOR MARENGO
FURNITURE OF 60 HORIZONTAL BAND OF 5 CM MARENGO COLOR

BALM3060 / HORI / 5 / MARENGO

ILUSTRACIÓN DEL MUEBLE HENDIDO VERTICAL
ILLUSTRATION OF VERTICAL SPLIT CABINET

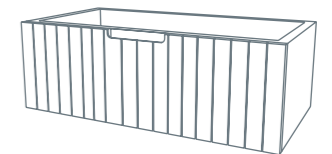

Acabados / Finishes



1.- Blanco. 2.- Beige. 3.- Arena. 4.- Sepia 5.- Burdeos. 6.- Oceano. 7.- Marengo. 8.- Negro. 9.- Vison. 10.- Gris. 11.- Malen. 12.- Verdone 13.- Azul. RAL.

*COLOR RAL incremento de un 25% segun tarifa.

Lavabos admitidos / supported sinks

· LAVABO DE ENCASTRE · SOBRE ENCIMERA (EN ESTE CASO AÑADIR TAPA SOBRE MUEBLE) · ADMITE FONDO REDUCIDO 38,5 SIN SOBRE COSTE.
· BUILT-IN WASHBASIN · OVER COUNTERTOP (IN THIS CASE, ADD A COVER OVER FURNITURE) · ADMITS REDUCED DEPTH 38.5 WITHOUT ADDITIONAL COST.

* INDICAR SI ES PORTALAVABO / INDICATE IF IT IS A BASIN HOLDER



Gaire.

Mueble práctico y versátil, se distingue por el sistema de apertura push para los cajones y por el material texturizado ultramate que caracteriza a este práctico mueble.

Practical and versatile piece of furniture, it is distinguished by the push-opening system for the drawers and by the ultra-matt textured material that characterizes this practical piece of furniture.



Gaire.

Modelo Gaire 90 acabado Riga 2 UND. / Espejo redondo 80, marco redondo 2 UND. / Encimera acabado cuarzo sin seno / Lavabo Gea acabado negro 2UND.

Gaire 90 model Riga finish 2 UNITS. / Round mirror 80, round frame 2 UNITS / Countertop quartz finish without sink / Gea washbasin black finish 2PCS



Medidas.

1 Cajón de 60 cm

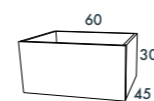

BALM 3060

HORI./VERT.

COLOR

1 Cajón de 80 cm

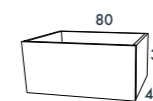

BALM 3080

HORI./VERT.

COLOR

1 Cajón de 90 cm

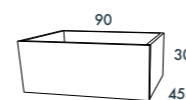

BALM 3090

HORI./VERT.

COLOR

1 Cajón de 100 cm

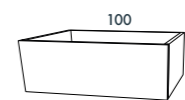

BALM 3100

HORI./VERT.

COLOR

1 Cajón de 120 cm

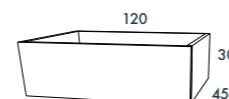

BALM 3120

HORI./VERT.

COLOR

2 cajones de 60 cm

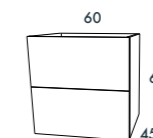

BALM 6060

HORI./VERT.

COLOR

2 cajones de 80 cm

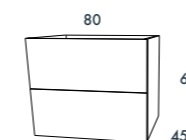

BALM 6080

HORI./VERT.

COLOR

2 cajones de 100 cm

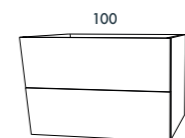

BALM 6100

HORI./VERT.

COLOR

2 cajones de 120 cm

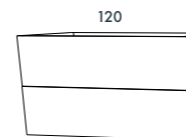

BALM 6120

HORI./VERT.

COLOR

LAVABOS ADMITIDOS :

· Lavabo de encastre · Lavabo sobre encimera (añadir tapa sobre mueble.)

· Fondo reducido 38,5 sin sobre coste.

Acabados.

FANTASIA · LAMINADO TEXTURIZADO RUGOSO CON ACABADO ULTRA MATE.

EL MATERIAL SERÁ EL MISMO PARA EL FRENTE Y EL MÓDULO.

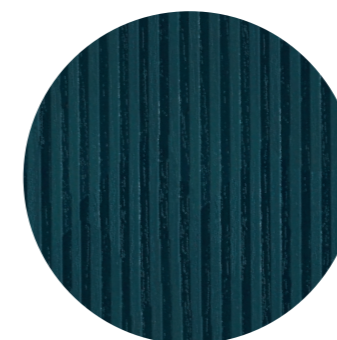

1. Riga.



2. Line.

* Módulo veta vertical.



Alpe

Mueble suspendido con o sin patas.
Frente enmarcado de 22 mm. y módulo de 19 mm.
Acabado en pintura laca mate.
Tirador asa metálica acabado en varios colores.

Suspended or legged furniture.
22 mm framed front. and module of 19 mm.
Finished in matt lacquer paint.
Metal handle handle finished in various colors.



Alpe

Alpe

Modelo Alpe 120 con patas.
Acabado gris Marengo, tirador oro rosa.
Sobre encimera de carga mineral avabado blanco.
Lavabo orta 2 und.
Alpe 120 model with legs.
Charcoal gray finish, rose gold handle.
White finished mineral load countertop.
Orta washbasin 2 und.

CODIGOS COMPOSICIÓN/COMPOSITION CODES

ALPE 85120 + PATAS + E20CF067 + LVBOORTA



Medidas.

2 cajones de 80

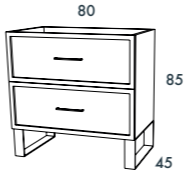

ALPE 8580 | LACA+(COLOR.) | TIR + (COLOR.)

2 cajones de 100

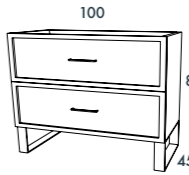

ALPE 10080 | LACA+(COLOR.) | TIR + (COLOR.)

4 cajones de 120

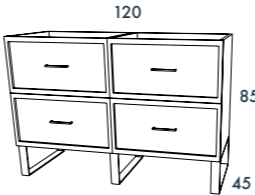

ALPE 85120 | LACA+(COLOR.) | TIR + (COLOR.)

4 cajones de 140

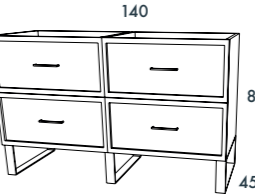

ALPE 85140 | LACA+(COLOR.) | TIR + (COLOR.)

*LAS PATAS METÁLICAS NO VAN INCLUIDAS, INDICAR EN EL PEDIDO EL SUPLEMENTO DE LAS PATAS EN EL CASO DE QUERER DEMANDARLAS. LAS PATAS METÁLICAS IRÁN PINTADAS DEL MISMO COLOR QUE EL MUEBLE.

*THE METAL LEGS ARE NOT INCLUDED, INDICATE IN THE ORDER THE SUPPLEMENT OF THE LEGS IN THE CASE OF WANTING TO DEMAND THEM. THE METAL LEGS WILL BE PAINTED IN THE SAME COLOR AS THE FURNITURE.

Colores tirador / Handle colours.

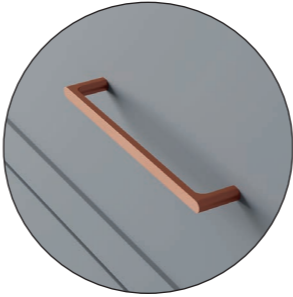

ORO ROSA.
PINK GOLD.

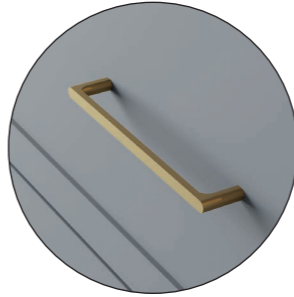

ORO.
GOLD.

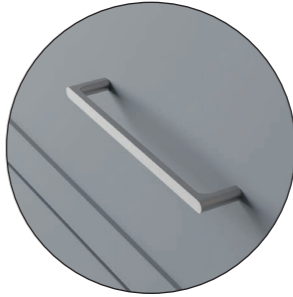

GRIS METALIZADO.
METALLIC GRAY.

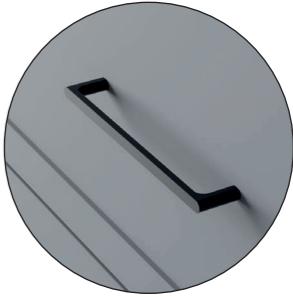

NEGRO METÁLICO.
METALLIC BLACK.

Lavabos admitidos / supported sinks

· LAVABO DE ENCASTRE · SOBRE ENCIMERA (EN ESTE CASO AÑADIR TAPA SOBRE MUEBLE) · ADMITE FONDO REDUCIDO 38,5 SIN SOBRE COSTE.

· BUILT-IN WASHBASIN · OVER COUNTERTOP (IN THIS CASE, ADD A COVER OVER FURNITURE) · ADMITS REDUCED DEPTH 38.5 WITHOUT ADDITIONAL COST.

* INDICAR SI ES PORTALAVABO / INDICATE IF IT IS A BASIN HOLDER.

Acabados. LACADO MATE.



1.- Blanco. 2.- Beige. 3.- Arena. 4.- Sepia. 5.- Burdeos. 6.- Oceano. 7.- Marengo. 8.- Negro. 9.- Vison. 10.- Gris. 11.- Malen. 12.- Verdone. 13.- Azul. RAL.

*COLOR RAL incremento de un 25% segun tarifa.



MarkoMadera.

Frente de 22 mm. enmarcado de madera maciza.
Módulo tablero rechapado de madera natural 19 mm.
Plafón rechapado de madera.
Tirador acabado negro mate.

22mm front. solid wood framed.
Natural wood veneered board module 19 mm.
Wood veneer ceiling.
Matte black finish handle.



MarkoMadera



MarkoMadera.

Modelo Marko madera 100. Nogal, espejo redondo 60 2 UND, lavabo Gio color beige, encimera cuarzo sin seno, juego de patas de 43 cm.

Marko model 100 wood. Walnut, round mirror 60 2 UND, beige Gio washbasin, quartz countertop without sink, set of 43 cm legs.

**CÓDIGOS COMPOSICIÓN:
MRKL3060 2 UND. / EL40X100 / LVAGDD12**

COMPOSITION CODES
MRKL3060 2 UND. / EL40X100 / LVAGDD12



Acabados. MADERA NATURAL.



1. NOGAL.



2. ROBLE.

Lavabos admitidos / supported sinks

- LAVABO DE ENCASTRE · SOBRE ENCIMERA (EN ESTE CASO AÑADIR TAPA SOBRE MUEBLE) · ADMITE FONDO REDUCIDO 38,5 SIN SOBRE COSTE.
- BUILT-IN WASHBASIN · OVER COUNTERTOP (IN THIS CASE, ADD A COVER OVER FURNITURE) · ADMITS REDUCED DEPTH 38.5 WITHOUT ADDITIONAL COST.

* INDICAR SI ES PORTALAVABO / INDICATE IF IT IS A BASIN HOLDER.

Medidas / Measures

1 cajón de 60 cm (60 x 45 x 30)



1 cajón de 70 cm (70 x 45 x 30)



1 cajón de 80 cm (80 x 45 x 30)



1 cajón de 90 cm (90 x 45 x 30)

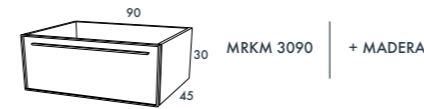

1 cajón de 100 cm (100 x 45 x 30)

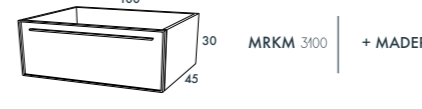

1 cajón de 120 cm (120 x 45 x 30)

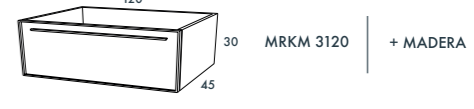

1 cajón con cajón interior de 60 cm (60 x 45 x 45)

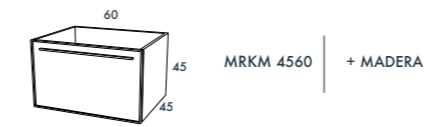

1 cajón con cajón interior de 70 cm (70 x 45 x 45)

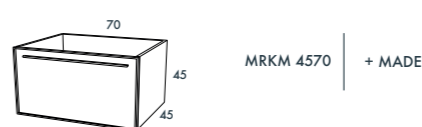

1 cajón con cajón interior de 80 cm (80 x 45 x 45)

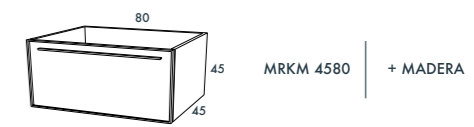

1 cajón con cajón interior de 90 cm (90 x 45 x 45)

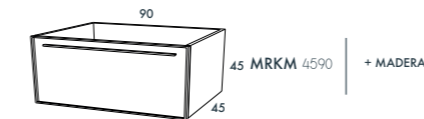

1 cajón con cajón interior de 100 cm (100 x 45 x 45)

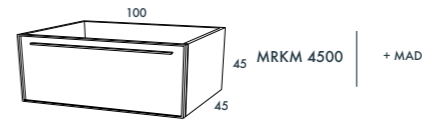

1 cajón con cajón interior de 120 cm (120 x 45 x 45)

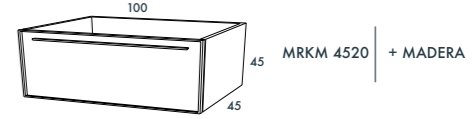

2 cajones de 60 cm (60 x 45 x 60)

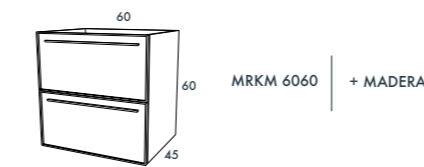

2 cajones de 70 cm (70 x 45 x 60)

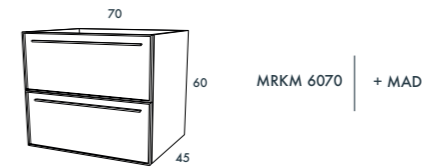

2 cajones de 80 cm (80 x 45 x 60)

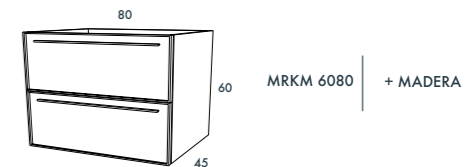

2 cajones de 90 cm (90 x 45 x 60)

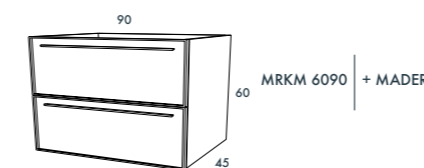

2 cajones de 100 cm (100 x 45 x 60)

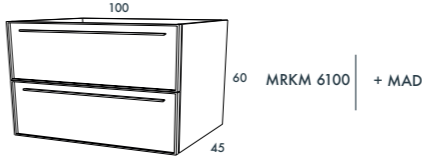

2 cajones de 100 cm (120 x 45 x 60)

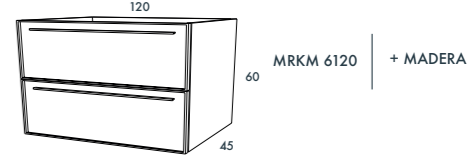

EJEMPLO DE CODIFICACIÓN PARA PEDIDO. EXAMPLE OF CODING FOR ORDER.

MUEBLE DE 2 CAJONES DE 80 ACABADO NOGAL.
FURNITURE WITH 2 DRAWERS OF 80 NOGAL FINISH.

MRKM 6080 / NOGAL.

*LAS PATAS METÁLICAS NO VAN INCLUIDAS, INDICAR EN EL PEDIDO EL SUPLEMENTO DE LAS PATAS EN EL CASO DE QUERER DEMANDARLAS.
LAS PATAS METÁLICAS IRÁN PINTADAS DEL MISMO COLOR QUE EL MUEBLE.

*THE METAL LEGS ARE NOT INCLUDED, INDICATE IN THE ORDER THE SUPPLEMENT OF THE LEGS IN THE CASE OF WANTING TO DEMAND THEM.



Mini.

Mueble compuesto.

LAVABO + MUEBLE CON FONDO REDUCIDO.

Apertura del mueble ingletado.

Lavabo cerámico acabado en blanco brillo.

Composite furniture.

WASHBASIN + FURNITURE WITH REDUCED DEPTH.

Opening of the mitered furniture.

Ceramic washbasin finished in glossy white.

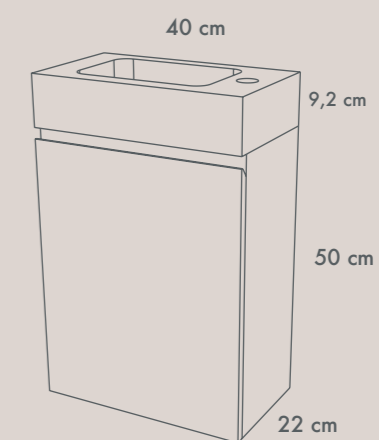

Medidas / Measures





Acabados.







LACADOS. BRILLO/MATE.

-  1.- Blanco.
-  2.- Beige.
-  3.- Arena.
-  4.- Sepia
-  5.- Burdeos
-  6.- Oceano.
-  7.- Marengo.
-  8.- Negro.
-  9.- Vison.
-  10.- Gris.
-  11.- Malen.
-  12.- Verdone
-  13.- Azul.
-  RAL. *El color RAL tendrá un incremento de un 25% según tarifa.





LAMINADOS.

-  1.- Blanco.
-  2.- Halifax.
-  3.- Nogal tostado.
-  4.- Nogal trufa.
-  5.- Roble wellles.
-  6.- Navarra arena.
-  7.- Roble nudo.
-  8.- Zayan.
-  9.- Chester.
-  10.- Hickory.
-  11.- Ulmus.



DECOMAT.

-  1.- Blanco.
-  2.- Arcilla.
-  3.- Cachemira.
-  4.- Macadan.
-  5.- Grafito
-  8.- Black.

FANTASIAS FANTASIES.

-  1.- Bottega.
-  2.- Riga.
-  3.- Vulcano.
-  4.- Line.

CHAPA NATURAL.

-  1.- Roble.
-  2.- Nogal.

COMPOSICIÓN: MUEBLE + LAVABO COMPOSITION: FURNITURE + WASHBASIN.

| DESCRIPCIÓN DESCRIPTION | MATERIAL MATERIAL | CÓDIGO CODE |
|---|--------------------|-------------|
| 1 PUERTA MALLA VERTICAL 1 VERTICAL MESH DOOR. | LAMINADO LAMINATED | MINILAMI |
| 1 PUERTA 1 DOOR. | DECOMAT LAMINATED | MINIDECO |
| 1 PUERTA MALLA VERTICAL 1 VERTICAL MESH DOOR. | FANTASIA FANTASIE | MINIFANT |
| 1 PUERTA 1 DOOR. | LACADO LAQUERED | MINILACA |
| 1 PUERTA MALLA VERTICAL 1 VERTICAL MESH DOOR. | MADERA WOOD | MINICHAP |

* MUEBLE 1 PUERTA + LAVABO (TIRADOR INGLETADO.) * 1 DOOR FURNITURE + WASHBASIN (MITRED HANDLE)

* EN EL PEDIDO SE DEBE ESPECIFICAR LA MANO DE APERTURA DE LA PUERTA. * IN THE ORDER, THE DOOR OPENING HAND MUST BE SPECIFIED

Horizon.

Horizon.

Modelo Horizon 90, acabado Ocean.
Espejo redondo marco negro de 90
Lavabo Thin 90.

Horizon 90 model, Ocean finish.
Round mirror with black frame from 90
Thin washbasin 91.

CODIGOS COMPOSICIÓN/COMPOSITION CODES
HORIZ090 / ESRNE090 / LVTHN090





Medidas.

2 cajones de 60 cm.

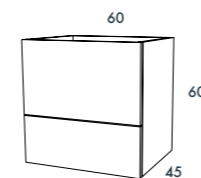

60 HORIZ060 | LACA | LAMINADO
ADMITE LAVABO CENTRADO Y REDUCIDO.

2 cajones de 80 cm.

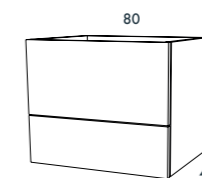

60 HORIZ080 | LACA | LAMINADO
ADMITE LAVABO CENTRADO Y REDUCIDO.

2 cajones de 90 cm.

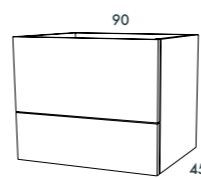

60 HORIZ090 | LACA | LAMINADO
ADMITE LAVABO CENTRADO DESPLAZADO Y REDUCIDO.

2 cajones de 100 cm. · ADMITE LAVABO CENTRADO Y REDUCIDO.

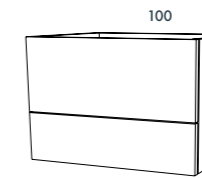

60 HORIZ100 | LACA | LAMINADO
ADMITE LAVABO CENTRADO DESPLAZADO Y REDUCIDO.

2 cajones de 100 cm.

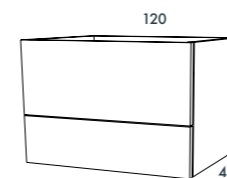

60 HORIZ120 | LACA | LAMINADO
ADMITE LAVABO CENTRADO DESPLAZADO Y 2 SENOS.

ADMITE ADMIT

- Lavabo de encastre
- Built-in washbasin
- Lavabo sobre encimera (añadir tapa sobre mueble)
- Countertop washbasin (add cover on furniture)
- Fondo reducido
- Reduced fund
- Admite fondo reducido 38.5. sin sobre coste.
- Supports reduced background 38.5. without extra cost.

Acabados. LAMINADOS / LACAS.

LAMINADOS LAMINATED

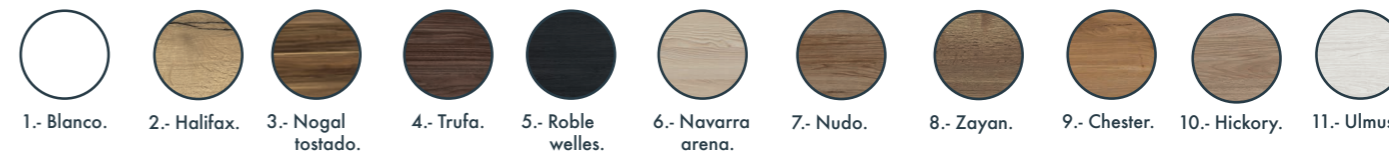

- 1.- Blanco. 2.- Halifax. 3.- Nogal tostado. 4.- Trufa. 5.- Roble wellles. 6.- Navarra arena. 7.- Nudo. 8.- Zayan. 9.- Chester. 10.- Hickory. 11.- Ulmus.

LACAS LAQUERED



- 1.- Blanco. 2.- Beige. 3.- Arena. 4.- Sepia. 5.- Burdeos. 6.- Oceano. 7.- Marengo. 8.- Negro. 9.- Vison. 10.- Gris. 11.- Malen.

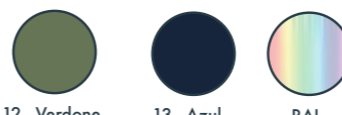

- 12.- Verdone 13.- Azul. RAL. *El color RAL tendrá un incremento de un 25% segun tarifa.

Quatro.

Modelo Quatro 90, acabado Beige.
Espejo Ovalado marco negro.
Tapa sobre mueble de 2 cm.
Lavabo Orta.

Quatro 80 model, Beige finish.
Oval mirror black frame.
Cover on furniture of 2 cm.
Orta washbasin.

CODIGOS COMPOSICIÓN/COMPOSITION CODES
QUAT090 / ESOVMN59 / LVBOORTA





Medidas.

Mueble de 60 cm.



Mueble de 80 cm.



Mueble de 90 cm.



Mueble de 100 cm.



Mueble de 120 cm.

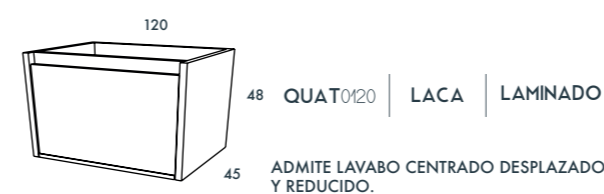

ADMITE ADMIT

- Lavabo de encastre
- Built-in washbasin
- Lavabo sobre encimera (añadir tapa sobre mueble)
- Countertop washbasin (add cover on furniture)
- Fondo reducido
- Reduced fund
- Admite fondo reducido 38.5. sin sobre coste.
- Supports reduced background 38.5. without extra cost.

Acabados Finishes.

LAMINADOS LAMINATED

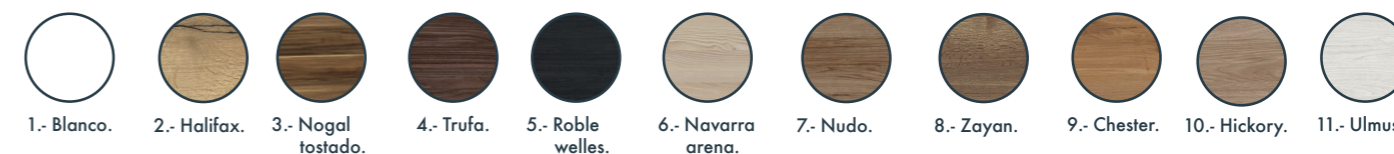

LACAS LAQUERED



*El color RAL tendrá un incremento de un 25% segun tarifa.

Medidas & Tarifa.

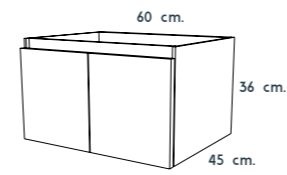

MO2PU060 Mod. laminado

1 MÓDULO 60 , 2 PUERTAS

Lavabos admitidos ·Centrado.
·Reducido.

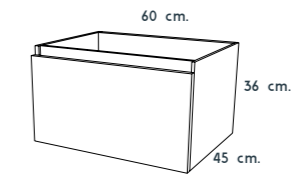

MO1CAJ060 Mod. laminado

1 MÓDULO 60 , 1 CAJON

Lavabos admitidos ·Centrado.
·Reducido.

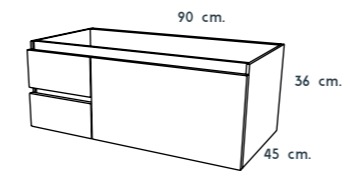

MO2PU090 Mod. laminado

1 MÓDULO 60
2 PUERTAS + 1 mod. 30, 2 caj.

Lavabos admitidos ·Desplazado

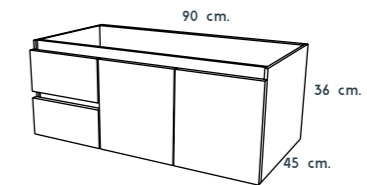

MO1CA090 Mod. laminado

1 MÓDULO 60
1 CAJON + 1 mod. 30, 2 caj.

Lavabos admitidos desplazado

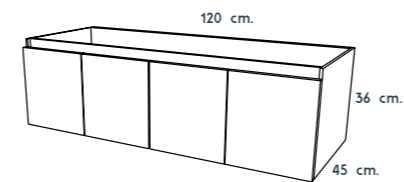

MO2PU120 Mod. laminado

2 MÓDULO 60 , 2 PUERTAS

Lavabos admitidos · 2 senos

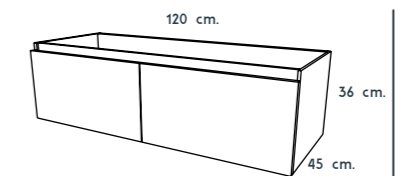

MO2CA120 Mod. laminado

2 MÓDULO 60 , 1 Cajon.

Lavabos admitidos 2 Senos.

Admite: Lavabo de encastre · Sobre encimera (En este caso añadir tapa sobre mueble) · Admite fondo reducido 38.5. sin sobre coste

Acabados. LAMINADOS.



1.- Blanco.



2.- Halifax.



3.- Nogal tostado.



4.- Trufa.



5.- Roble wellles.



6.- Navarra arena.



7.- Nudo.



8.- Zayan.



9.- Chester.



10.- Hickory.



11.- Ulmus.

Modelo susp. 120, material laminado blanco.

Espejo Elegance 120X80 cm.

Lavabo Thin 2 senos.

Suspended model 120, white laminated material.

Elegance mirror 120X80 cm.

Thin 2 bowl washbasin.



Modelo suspendido de 80, gris cachemira.
 Espejo Minimal 80 x80 cm.
 Lavabo thin seno centrado.
 Suspended model from the 80s, cashmere grey.
 Minimal mirror 80 x 80 cm.
 Centered thin bowl washbasin.

Acabados.



Mueble de 60 cm.

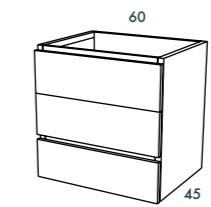

TOOMU060 | DECOMAT | LAMINADO

ADMITE LAVABO CENTRADO Y REDUCIDO.

Mueble de 80 cm.

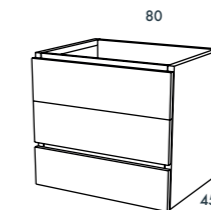

TOOMU060 | DECOMAT | LAMINADO

ADMITE LAVABO CENTRADO Y REDUCIDO.

Mueble de 90 cm.

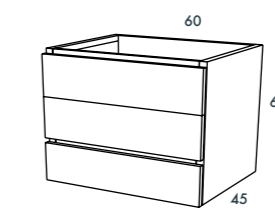

TOOMU090 | DECOMAT | LAMINADO

ADMITE LAVABO CENTRADO REDUCIDO Y DESPLAZADO.

Mueble de 100 cm.

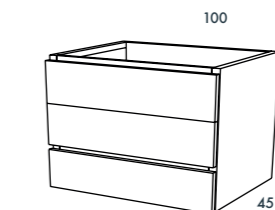

TOOMU100 | DECOMAT | LAMINADO

ADMITE LAVABO CENTRADO REDUCIDO Y DESPLAZADO.

Admite: · Lavabo de encastre · Sobre encimera (En este caso añadir tapa sobre mueble) · Admite fondo reducido 38.5. sin sobre coste.

Acabados Finishes.

LAMINADOS LAMINATED



- 1.- Blanco.
- 2.- Halifax.
- 3.- Nogal tostado.
- 4.-Trufa.
- 5.- Roble wellles.
- 6.- Navarra arena.
- 7.- Nudo.
- 8.- Zayan.
- 9.- Chester.
- 10.- Hickory.
- 11.- Ulmus.

DECOMAT

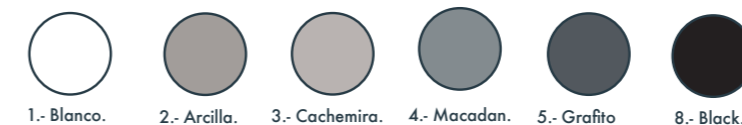

- 1.- Blanco.
- 2.- Arcilla.
- 3.- Cachemira.
- 4.- Macadan.
- 5.- Grafito
- 8.- Black.



Modelo Toomuchplus 80.
Material Decomat gris macadan.
Espejo Minimal. 80x80
Thin seno centrado.

Toomuch plus 80 model
Macadam gray Decomat material.
Minimal mirror. 80x80
Thin centered sinus.

Medidas.



Mueble de 60 cm.

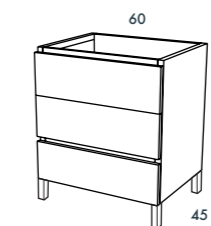

TOOMU060 | DECOMAT | LAMINADO

ADMITE LAVABO CENTRADO Y REDUCIDO.

Mueble de 80 cm.

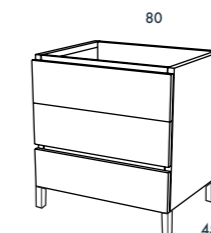

TOOMU060 | DECOMAT | LAMINADO

ADMITE LAVABO CENTRADO Y REDUCIDO.

Mueble de 90 cm.

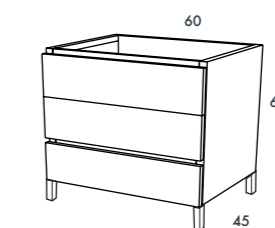

TOOMU090 | DECOMAT | LAMINADO

ADMITE LAVABO CENTRADO REDUCIDO Y DESPLAZADO.

Mueble de 100 cm.

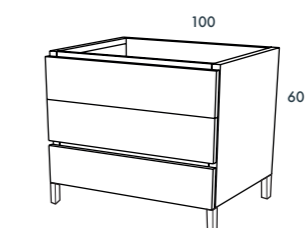

TOOMU100 | DECOMAT | LAMINADO

ADMITE LAVABO CENTRADO REDUCIDO Y DESPLAZADO.

Admite: · Lavabo de encastre · Sobre encimera (En este caso añadir tapa sobre mueble) · Admite fondo reducido 38.5. sin sobre coste.

Acabados Finishes.

LAMINADOS LAMINATED



DECOMAT

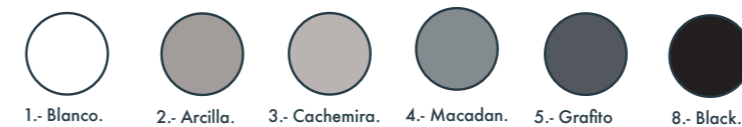



Modelo susp. Floop 80 , material módulo decomat arcilla.
 Material frentes decomat black.
 Espejo Minimal 80x80.
 Lavabo Thin seno centrado.
 Suspended model Floop 80, decomat clay module material.
 Decomat black front material.
 Minimal mirror 80x80.
 Thin centered basin

Medidas.

Mueble de 60 cm.

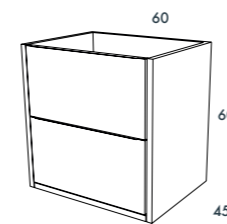

FLOOP060 | DECOMAT | LAMINADO
 ADMITE LAVABO CENTRADO Y REDUCIDO.

Mueble de 80 cm.

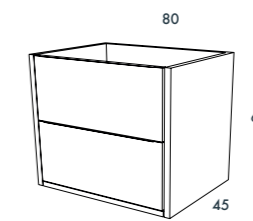

FLOOP080 | DECOMAT | LAMINADO
 ADMITE LAVABO CENTRADO Y REDUCIDO.

Mueble de 90 cm.

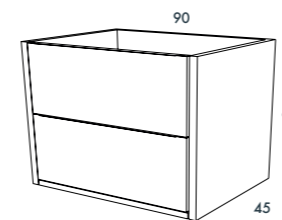

FLOOP090 | DECOMAT | LAMINADO
 ADMITE LAVABO CENTRADO DESPLAZADO Y REDUCIDO.

Mueble de 100 cm.

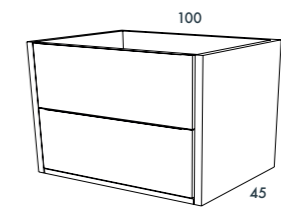

FLOOP100 | DECOMAT | LAMINADO
 ADMITE LAVABO CENTRADO DESPLAZADO Y REDUCIDO.

Mueble de 120 cm.

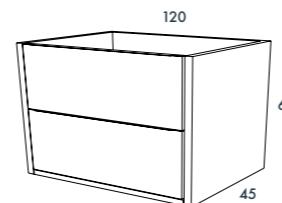

FLOOP120 | DECOMAT | LAMINADO
 ADMITE LAVABO CENTRADO DESPLAZADO REDUCIDO Y DOS SENOS.

ADMITE ADMIT

- Lavabo de encastre
- Built-in washbasin
- Lavabo sobre encimera (añadir tapa sobre mueble)
- Countertop washbasin (add cover on furniture)
- Fondo reducido
- Reduced fund
- Admite fondo reducido 38.5. sin sobre coste.
- Supports reduced background 38.5. without extra cost.

Acabados Finishes

LAMINADOS LAMINATED

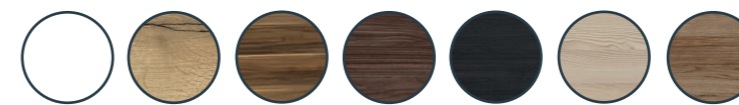

1.- Blanco. 2.- Halifax. 3.- Nogal tostado. 4.-Trufa. 5.- Roble wellles. 6.- Navarra arena. 7.- Nudo.



8.- Zayan. 9.- Chester. 10.- Hickory. 11.- Ulmus.

Decomat.



1.- Blanco. 2.- Arcilla. 3.- Cachemira. 4.- Macadan.



5.- Grafito 8.- Black.



Modelo susp. 80, material módulo decomat black.
 Material frentes decomat arcilla.
 Espejo Minimal 80x80, lavabo Thin seno centrado.

Suspended model 80, module material decomat black.
 Material fronts decomat clay.
 Minimal 80x80 mirror, Thin centered basin.

Medidas.

Mueble de 60 cm.

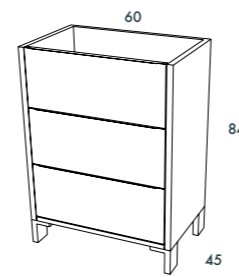

FLOOP060 | DECOMAT | LAMINADO

ADMITE LAVABO CENTRADO Y REDUCIDO.

Mueble de 80 cm.

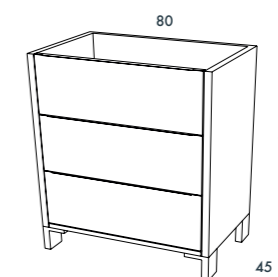

FLOOP080 | DECOMAT | LAMINADO

ADMITE LAVABO CENTRADO Y REDUCIDO.

Mueble de 90 cm.

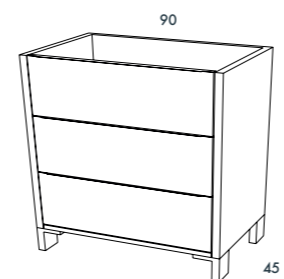

FLOOP090 | DECOMAT | LAMINADO

ADMITE LAVABO CENTRADO DESPLAZADO Y REDUCIDO.

Mueble de 100 cm.

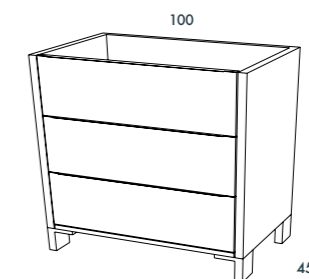

FLOOP100 | DECOMAT | LAMINADO

ADMITE LAVABO CENTRADO DESPLAZADO Y REDUCIDO.

Mueble de 120 cm.

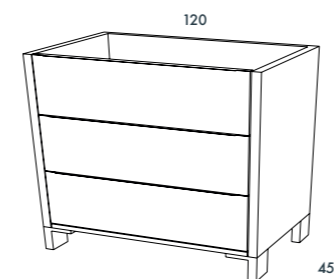

FLOOP120 | DECOMAT | LAMINADO

ADMITE LAVABO CENTRADO DESPLAZADO REDUCIDO Y DOS SENOS.

ADMITE ADMIT

- Lavabo de encastre
- Built-in washbasin
- Lavabo sobre encimera (añadir tapa sobre mueble)
- Countertop washbasin (add cover on furniture)
- Fondo reducido
- Reduced fund
- Admite fondo reducido 38.5. sin sobre coste.
- Supports reduced background 38.5. without extra cost.

Acabados Finishes

Laminado Laminated

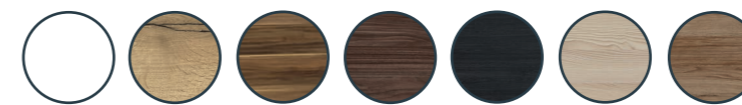

1.- Blanco. 2.- Halifax. 3.- Nogal tostado. 4.- Trufa. 5.- Roble welles. 6.- Navarra arena. 7.- Nudo.



8.- Zayan. 9.- Chester. 10.- Hickory. 11.- Ulmus.

Decomat.



1.- Blanco. 2.- Arcilla. 3.- Cachemira. 4.- Macadan.



5.- Grafito 8.- Black.



Tiles.

Modelo Tiles 90, acabado Roble welles
Espejo redondo marco negro de 90
Lavabo Gio

Tiles 90 model, Welles Oak finish
Round mirror with black frame from 90
Gio washbasin



Medidas · Measures

Mueble de 80 cm · 80 cm furniture.

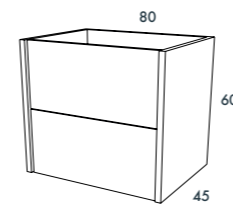

TILES080 | DECOMAT | LAMINADO

Mueble de 90 cm · 90 cm furniture.

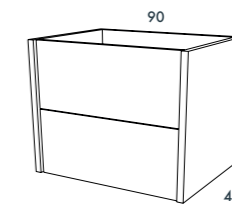

TILES090 | DECOMAT | LAMINADO

Mueble de 100 cm · 100 cm furniture.

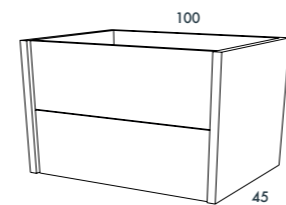

TILES100 | DECOMAT | LAMINADO

Mueble de 120 cm · 120 cm furniture.

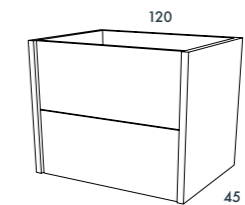

TILES120 | DECOMAT | LAMINADO

ADMITE LAVABO SOBRE ENCIMERA · NO ADMITE FONDO REDUCIDO · MEASURES ADMITS COUNTERTOP WASHBASIN · DOES NOT ADMIT REDUCED DEPTH.

Acabados. LAMINADOS.

LACA.

-  1.- Blanco.
-  2.- Halifax.
-  3.- Nogal tostado.
-  4.- Trufa.
-  5.- Roble wellles.
-  6.- Navarra arena.
-  7.- Nudo.
-  8.- Zayan.
-  9.- Chester.
-  10.- Hickory.
-  11.- Ulmus.
-  1.- Blanco.

Manhatan.

Modelo Manhatan 100, acabado Blanco
Espejo redondo marco negro de 90
Lavabo Furnab, tapa sobre mueble de 2 cm
acabado halifax.

Manhattan 100 model, White finish
Round mirror with black frame from 90
Furnab washbasin, top on 2 cm furniture,
halifax finish.



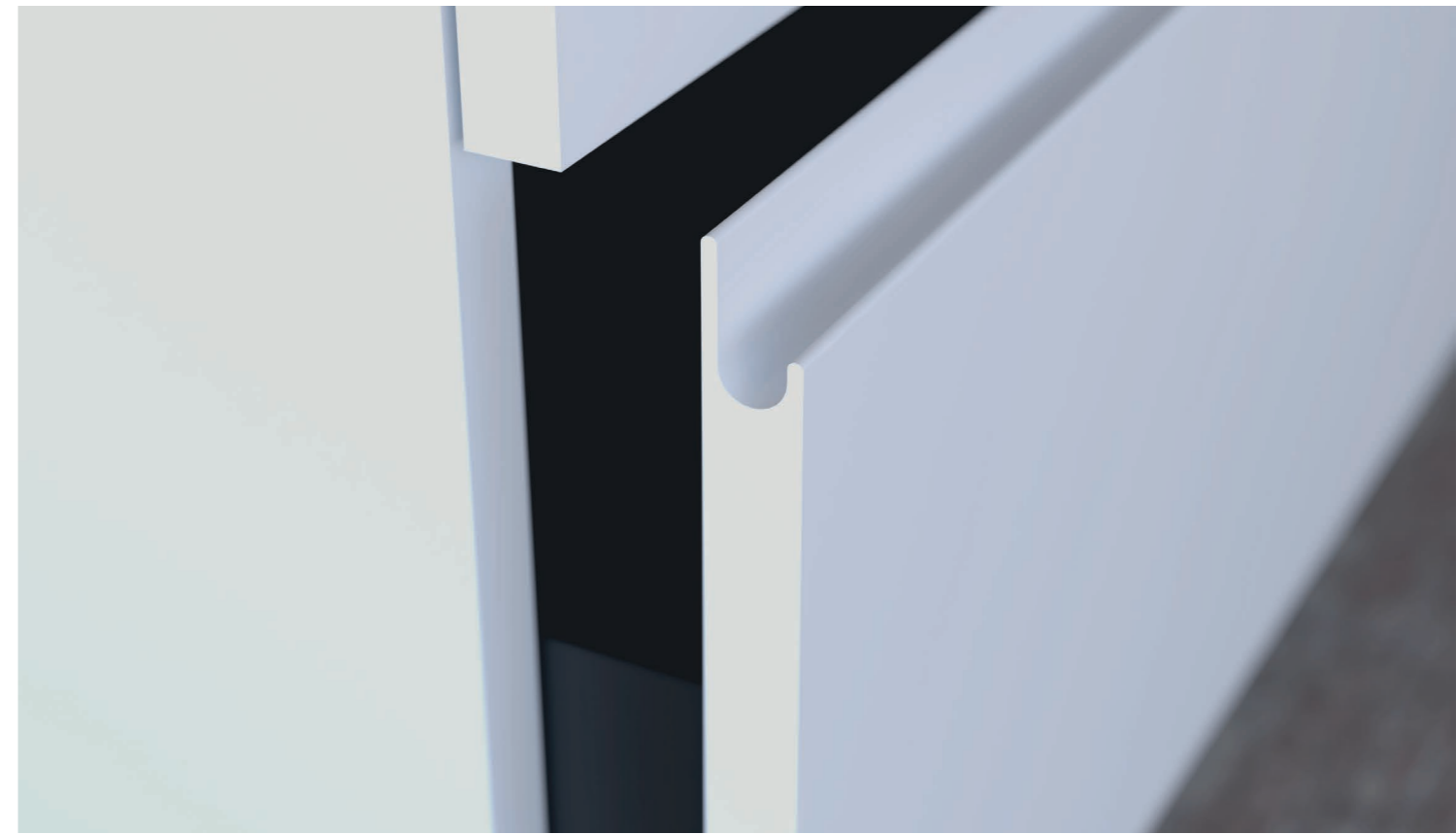

Medidas. Admite: Lavabo de encastre · Sobre encimera (En este caso añadir tapa sobre mueble) · Admite fondo reducido 38.5. sin sobre coste.

Mueble de 60 cm · 60 cm furniture.

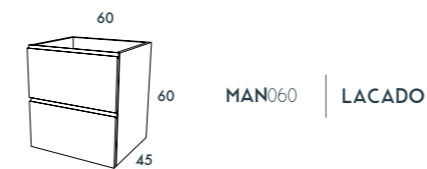

ADMITE LAVABO CENTRADO Y REDUCIDO.

Mueble de 80 cm · 80 cm furniture.

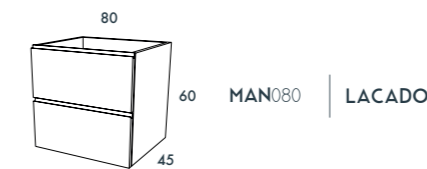

ADMITE LAVABO CENTRADO Y REDUCIDO.

Mueble de 90 cm · 90 cm furniture.



ADMITE LAVABO CENTRADO DESPLAZADO Y REDUCIDO.

Mueble de 100 cm · 100 cm furniture.

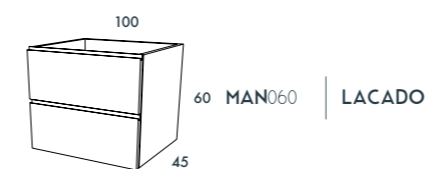

ADMITE LAVABO CENTRADO DESPLAZADO Y REDUCIDO.

Mueble de 120 cm · 120 cm furniture.

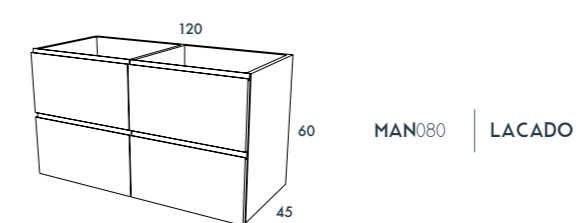

ADMITE LAVABO 2 SENOS DESPLAZADO DERECHA / IZQUIERDA.

Acabados. LACADO MATE.



*COLOR RAL incremento de un 25% según tarifa.

Serie
IMAGINA

Combinalo a tu gusto.

Sistemas de apertura.

1. INGLETADO.



Sistema de apertura mecanizado en el propio frente, sin necesidad de añadir un tirador físico.

Mechanized opening system on the front itself, without the need to add a physical handle.

Materiales admitidos · Supported materials.

- LAMINADO LAMINATED · LACADOS LACQUERED · CHAPA MADERA NATURAL
- DECOMAT DECOMAT · FANTASIAS FANTASIES · NATURAL WOODEN VENEER

2. PESTAÑA.



Sistema de apertura tirador lineal de aluminio situado en el canto superior de el frente.

Linear aluminum handle opening system located on the upper edge of the front.

Materiales admitidos · Supported materials.

- LAMINADO LAMINATED · LACADOS LACQUERED · CHAPA MADERA NATURAL
- DECOMAT DECOMAT · FANTASIAS FANTASIES · NATURAL WOODEN VENEER

3. PARIS.



2.1 PARIS IZQUIERDA.



2.2 PARIS CENTRADO.



2.3 PARIS DERECHA.

Materiales admitidos.

- LACADOS
- LACQUERED

Sistema de apertura mecanizado en el propio frente, creando una hendidura con cato redondeado.

Sistemas de apertura.

4. MANHATAN.



Sistema de apertura mecanizado en el propio frente, sin necesidad de añadir un tirador físico.

Mechanized opening system on the front itself, without the need to add a physical handle.

Materiales admitidos · Supported materials.

- LACADOS LACQUERED

5. UÑERO JEY.



Sistema de apertura con tirador uñero de aluminio acabado inox, situado en el canto superior del frente. Tirador acabado negro mate 12€ de incremento por unidad.

Opening system with stainless steel-finish aluminum handle, located on the upper edge of the front. Handle in matt black finish €12 increase per unit.

Materiales admitidos · Supported materials.

- LAMINADO LAMINATED · LACADOS LACQUERED · CHAPA MADERA NATURAL
- DECOMAT DECOMAT · FANTASIAS FANTASIES · NATURAL WOODEN VENEER

6. PUSH.

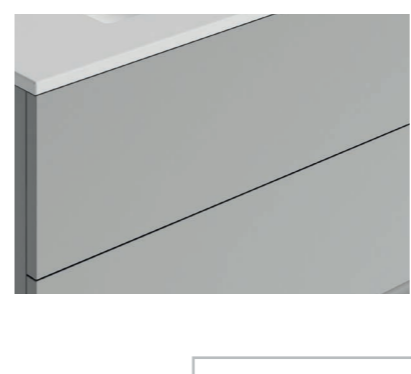

Materiales admitidos · Supported materials.

- LAMINADO LAMINATED · LACADOS LACQUERED · CHAPA MADERA NATURAL
- DECOMAT DECOMAT · FANTASIAS FANTASIES · NATURAL WOODEN VENEER

TODA LA SERIE IMAGINA.

- EN MEDIDAS 50/60/70/80/90/100/120 INDICAR SI DEBE LLEVAR MECANIZADO PARA EL SIFÓN
- FONDO STANDARD 45.
- ADMITE FONDO REDUCIDO DE 38,5 SIN SOBRE COSTE.
- MEDIDAS ESPECIALES 30% SOBRE LA INMEDIATA SUPERIOR.



IMAGINA • Ingletado.

Sistema de apertura mecanizado en el propio frente a 45°.
Machined opening system on the front itself at 45°.

Mueble 1 cajón de 60 acabado nogal trufa 2 UNDS.
Espejo Minimal 120x80 cm.
Lavabo Solidsurface faldón de 10 cm acabado blanco mate 120x45 cm.
Escuadras encimera solid faldón 2 UNID.

1 drawer cabinet of 60 truffle nogal finish 2 UNITS.
Minimal mirror 120x80 cm.
Solidsurface washbasin skirted 10 cm matte white finish 120x45 cm.
Solid skirted countertop brackets 2 UNITS.

CÓDIGOS COMPOSICIÓN • COMPOSITION CODES :

IMIG3060 X 2 UND. / MI080X120 / LVFS1200 / ESCUADSS X 2 UND. / TSMLAM19.



MÓDULO SUSPENDIDO DE UN CAJÓN.

SUSPENDED MODULE WITH ONE DRAWER.

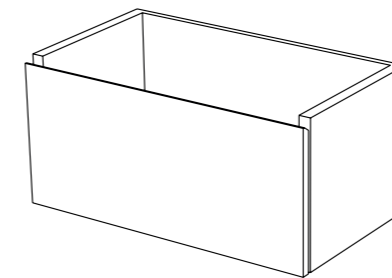

*En las medidas 50/60/70/80/90/100/120 indicar si debe llevar mecanizado para el sifón.

| ALTURA HEIGHT | ANCHURA WIDTH | CÓDIGO CODE | MATERIALES ADMITIDOS ADMITTED MATERIALS |
|------------------|------------------|----------------|--|
| 30 CM. | 30 CM. | IMIG3030 | |
| 40 CM. | 40 CM. | IMIG3040 | · LAMINADOS · LAMINATED |
| *50 CM. | *50 CM. | IMIG3050 | · DECOMAT · DECOMAT |
| *60 CM. | *60 CM. | IMIG3060 | · FANTASIAS · FANTASIES |
| *70 CM. | *70 CM. | IMIG3070 | |
| *80 CM. | *80 CM. | IMIG3080 | · LACA · LAQUERED |
| *90 CM. | *90 CM. | IMIG3090 | · CHAPA · LOCK |
| *100 CM. | *100 CM. | IMIG3100 | |
| *120 CM. | *120 CM. | IMIG3120 | |

MÓDULO SUSPENDIDO DE DOS CAJONES.

SUSPENDED MODULE WITH TWO DRAWER.

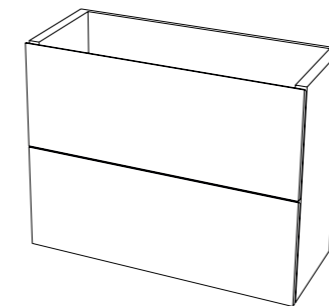

*En las medidas 50/60/70/80/90/100/120 indicar si debe llevar mecanizado para el sifón.

| ALTURA HEIGHT | ANCHURA WIDTH | CÓDIGO CODE | MATERIALES ADMITIDOS ADMITTED MATERIALS |
|------------------|------------------|----------------|--|
| 60 CM. | 30 CM. | IMIG6030 | |
| 60 CM. | 40 CM. | IMIG6040 | · LAMINADOS · LAMINATED |
| 60 CM. | *50 CM. | IMIG6050 | · DECOMAT · DECOMAT |
| 60 CM. | *60 CM. | IMIG6060 | · FANTASIAS · FANTASIES |
| 60 CM. | *70 CM. | IMIG6070 | |
| 60 CM. | *80 CM. | IMIG6080 | · LACA · LAQUERED |
| 60 CM. | *90 CM. | IMIG6090 | · CHAPA · LOCK |
| 60 CM. | *100 CM. | IMIG6100 | |
| 60 CM. | *120 CM. | IMIG6120 | |

MEDIDAS • MEASURES.

MÓDULO DE 1/2 PUERTAS CON ESTANTE INTERIOR.

1/2 DOOR MODULE WITH INTERIOR SHELF.

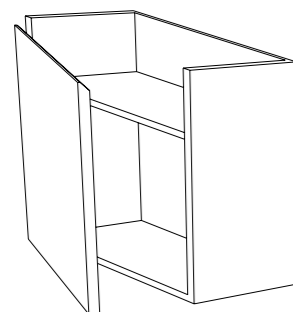

| | ANCHURA WIDTH | ALTO DE 45 HIGH 45 | ALTO DE 60 HIGH 60 | MATERIALES ADMITIDOS ADMITTED MATERIALS |
|-------------------|------------------|-----------------------|-----------------------|--|
| 1 PUERTA 1DOOR. | 30 CM. | IMPG4530 | IMPG6030 | |
| 1 PUERTA 1DOOR. | 40 CM. | IMPG4540 | IMPG6040 | · LAMINADOS · LAMINATED |
| 1 PUERTA 1DOOR. | *50 CM. | IMPG4550 | IMPG6050 | · DECOMAT · DECOMAT |
| 1 PUERTA 1DOOR. | *60 CM. | IMPG4560 | IMPG6060 | · FANTASIAS · FANTASIES |
| 2 PUERTAS 2DOORS. | *60 CM. | IMPG4626 | IMPG6026 | · LACA · LAQUERED |
| 2 PUERTAS 2DOORS. | *70 CM. | IMPG4570 | IMPG6070 | · CHAPA · LOCK |
| 2 PUERTAS 2DOORS. | *80 CM. | IMPG4580 | IMPG6080 | |
| 2 PUERTAS 2DOORS. | *90 CM. | IMPG4590 | IMPG6090 | |
| 2 PUERTAS 2DOORS. | *100 CM. | IMPG4510 | IMPG6100 | |
| 2 PUERTAS 2DOORS. | *120 CM. | IMPG4512 | IMPG6120 | |

*En las medidas 50/60/70/80/90/100/120 indicar si es portlavabo.
*INDICAR MANO DE APERTURA PUERTA : IZQUIERDA / DERECHA.

MÓDULO SUSPENDIDO CON CAJÓN INTERIOR.

SUSPENDED MODULE WITH INTERIOR DRAWER.

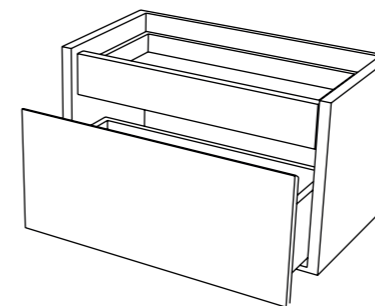

*En las medidas 50/60/70/80/90/100/120 indicar si debe llevar mecanizado para el sifón.

| ALTURA HEIGHT | ANCHURA WIDTH | CÓDIGO CODE | MATERIALES ADMITIDOS ADMITTED MATERIALS |
|------------------|------------------|----------------|--|
| 45 CM. | 30 CM. | IMIG4530 | |
| 45 CM. | 40 CM. | IMIG4540 | · LAMINADOS · LAMINATED |
| 45 CM. | *50 CM. | IMIG4550 | · DECOMAT · DECOMAT |
| 45 CM. | *60 CM. | IMIG4560 | · FANTASIAS · FANTASIES |
| 45 CM. | *70 CM. | IMIG4570 | |
| 45 CM. | *80 CM. | IMIG4580 | · LACA · LAQUERED |
| 45 CM. | *90 CM. | IMIG4590 | · CHAPA · LOCK |
| 45 CM. | *100 CM. | IMIG4510 | |
| 45 CM. | *120 CM. | IMIG4512 | |



IMAGINA · Manhattan.

Sistema de apertura mecanizado en el propio frente, sin necesidad de un tirador físico.
Machined opening system on the front itself, without the need to add a fixed handle.

Mueble portlavabo 2 cajones de 80 cm. lacado blanco mate. 2 UNIDADES. Módulo decorativo de 20x60 cm. hueco vertical. acabado Halifax. Toallero extraíble. Tapa sobre mueble 38 mm. 200x46cm. acabado Halifax. Lavabo Fornos blanco brillo. 2 UNIDADES.

Basin unit with 2 drawers of 80 cm. matt white lacquered. 2 UNITS. 20x60 cm decorative module. vertical hole. Halifax finish. Removable towel rack. Furniture cover 38 mm. 200x46cm. Halifax finish. Glossy white Fornos washbasin. 2 UNITS.

CÓDIGOS COMPOSICIÓN · COMPOSITION CODES :
IMMH6080 X 2 UND. / IMDB1620 X 2 UND. / TOALEXTC / TSMLAM38 / LVFURNAB.



MÓDULO SUSPENDIDO DE UN CAJÓN.

SUSPENDED MODULE WITH ONE DRAWER.

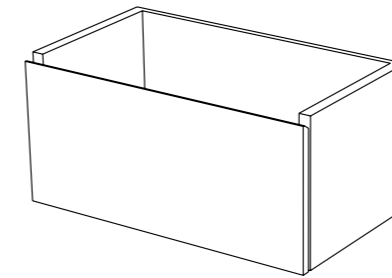

*En las medidas 50/60/70/80/90/100/120 indicar si debe llevar mecanizado para el sifón.

| ALTURA HEIGHT | ANCHURA WIDTH | CÓDIGO CODE | MATERIALES ADMITIDOS ADMITTED MATERIALS |
|------------------|------------------|----------------|--|
| 30 CM. | 30 CM. | IMMH3030 | <ul style="list-style-type: none"> · LAMINADOS · LAMINATED · DECOMAT · DECOMAT · FANTASIAS · FANTASIES · LACA · LAQUERED · CHAPA · LOCK |
| 40 CM. | 40 CM. | IMMH3040 | |
| *50 CM. | *50 CM. | IMMH3050 | |
| *60 CM. | *60 CM. | IMMH3060 | |
| *70 CM. | *70 CM. | IMMH3070 | |
| *80 CM. | *80 CM. | IMMH3080 | |
| *90 CM. | *90 CM. | IMMH3090 | |
| *100 CM. | *100 CM. | IMMH3100 | |
| *120 CM. | *120 CM. | IMMH3120 | |

MÓDULO SUSPENDIDO DE DOS CAJONES.

SUSPENDED MODULE WITH TWO DRAWER.

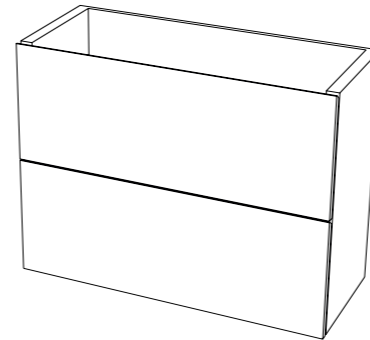

*En las medidas 50/60/70/80/90/100/120 indicar si debe llevar mecanizado para el sifón.

| ALTURA HEIGHT | ANCHURA WIDTH | CÓDIGO CODE | MATERIALES ADMITIDOS ADMITTED MATERIALS |
|------------------|------------------|----------------|--|
| 60 CM. | 30 CM. | IMMH6030 | <ul style="list-style-type: none"> · LAMINADOS · LAMINATED · DECOMAT · DECOMAT · FANTASIAS · FANTASIES · LACA · LAQUERED · CHAPA · LOCK |
| 60 CM. | 40 CM. | IMMH6040 | |
| 60 CM. | *50 CM. | IMMH6050 | |
| 60 CM. | *60 CM. | IMMH6060 | |
| 60 CM. | *70 CM. | IMMH6070 | |
| 60 CM. | *80 CM. | IMMH6080 | |
| 60 CM. | *90 CM. | IMMH6090 | |
| 60 CM. | *100 CM. | IMMH6100 | |
| 60 CM. | *120 CM. | IMMH6120 | |

MEDIDAS · MEASURES.

MÓDULO DE 1/2 PUERTAS CON ESTANTE INTERIOR.

1/2 DOOR MODULE WITH INTERIOR SHELF.

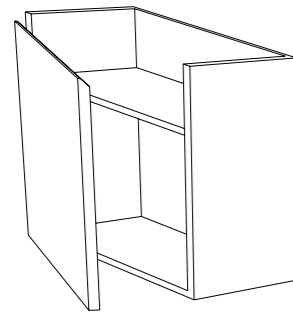

| | ANCHURA WIDTH | ALTO DE 45 HIGH 45 | ALTO DE 60 HIGH 60 | MATERIALES ADMITIDOS ADMITTED MATERIALS |
|-------------------|------------------|-----------------------|-----------------------|--|
| 1 PUERTA 1DOOR. | 30 CM. | IMMH4530 | IMMH6030 | <ul style="list-style-type: none"> · LAMINADOS · LAMINATED · DECOMAT · DECOMAT · FANTASIAS · FANTASIES · LACA · LAQUERED · CHAPA · LOCK |
| 1 PUERTA 1DOOR. | 40 CM. | IMMH4540 | IMMH6040 | |
| 1 PUERTA 1DOOR. | *50 CM. | IMMH4550 | IMMH6050 | |
| 1 PUERTA 1DOOR. | *60 CM. | IMMH4560 | IMMH6060 | |
| 2 PUERTAS 2DOORS. | *60 CM. | IMMH4560 | IMMH6060 | |
| 2 PUERTAS 2DOORS. | *70 CM. | IMPG4570 | IMMH6060 | |
| 2 PUERTAS 2DOORS. | *80 CM. | IMMH4580 | MMH6080 | |
| 2 PUERTAS 2DOORS. | *90 CM. | IMMH4590 | IMMH6090 | |
| 2 PUERTAS 2DOORS. | *100 CM. | IMMH4510 | IMMH6100 | |
| 2 PUERTAS 2DOORS. | *120 CM. | IMMH4512 | IMMH6120 | |

*En las medidas 50/60/70/80/90/100/120 indicar si es portalavabo.
*INDICAR MANO DE APERTURA PUERTA : IZQUIERDA / DERECHA.

MÓDULO SUSPENDIDO CON CAJÓN INTERIOR.

SUSPENDED MODULE WITH INTERIOR DRAWER.

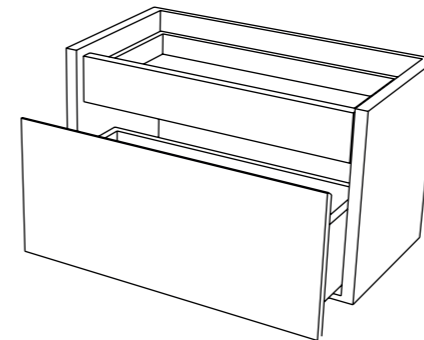

*En las medidas 50/60/70/80/90/100/120 indicar si debe llevar mecanizado para el sifón.

| ALTURA HEIGHT | ANCHURA WIDTH | CÓDIGO CODE | MATERIALES ADMITIDOS ADMITTED MATERIALS |
|------------------|------------------|----------------|--|
| 45 CM. | 30 CM. | IMMH4530 | <ul style="list-style-type: none"> · LAMINADOS · LAMINATED · DECOMAT · DECOMAT · FANTASIAS · FANTASIES · LACA · LAQUERED · CHAPA · LOCK |
| 45 CM. | 40 CM. | IMMH4540 | |
| 45 CM. | *50 CM. | IMMH4550 | |
| 45 CM. | *60 CM. | IMMH4560 | |
| 45 CM. | *70 CM. | IMMH4570 | |
| 45 CM. | *80 CM. | IMMH4570 | |
| 45 CM. | *90 CM. | IMMH4580 | |
| 45 CM. | *100 CM. | IMMH4590 | |
| 45 CM. | *120 CM. | IMMH4510 | |



Pestaña · IMAGINA.

IMAGINA · Pestaña.

Sistema de apertura compuesto por un tirador lineal de aluminio situado en la parte superior de el frente.

Opening system composed of a linear aluminum handle located in the upper part of the front.

Mueble 1 cajón de 40 cm. acabado Navarra arena. Mueble portavavabo 1 cajón de 80 cm. acabado Navarra arena. Mueble 1 cajón de 120 cm. acabado Navarra arena. Lavabo Solid surface blanco mate. Espejo Minimal 120.

Furniture 1 drawer of 40 cm. Navarra sand finish. Vanity unit with 1 drawer of 80 cm. Navarra sand finish. Cabinet with 1 drawer of 120 cm. Navarra sand finish. Matt white solid surface washbasin. Minimal mirror 120.

CÓDIGOS COMPOSICIÓN. · COMPOSITION CODES · IMTÑ3040 / IMTÑ3080 / IMTÑ3120 / LVFS1201 / MI080X120

MÓDULO DE 1/2 PUERTAS CON ESTANTE INTERIOR.

1/2 DOOR MODULE WITH INTERIOR SHELF.

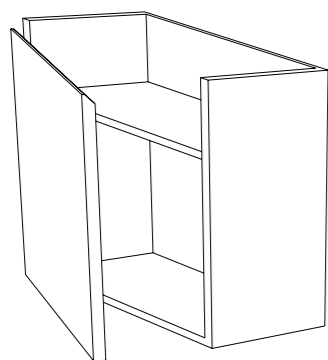

| | ANCHURA WIDTH | ALTO DE 45 HIGH 45 | ALTO DE 60 HIGH 60 | MATERIALES ADMITIDOS ADMITTED MATERIALS |
|------------------|------------------|-----------------------|-----------------------|--|
| 1 PUERTA 1DOOR | 30 CM. | IMPÑ4530 | IMPÑ6030 | |
| 1 PUERTA 1DOOR | 40 CM. | IMPÑ4540 | IMPÑ6040 | · LAMINADOS · LAMINATED |
| 1 PUERTA 1DOOR | *50 CM. | IMPÑ4550 | IMPÑ6050 | · DECOMAT · DECOMAT |
| 1 PUERTA 1DOOR | *60 CM | IMPÑ4560 | IMPÑ6060 | · FANTASIAS · FANTASIES |
| 2 PUERTAS 2DOORS | *60 CM | IMPÑ4560 | IMPÑ4560 | · LACA · LAQUERED |
| 2 PUERTAS 2DOORS | *70 CM. | IMPÑ4570 | IMPÑ6070 | · CHAPA · LOCK |
| 2 PUERTAS 2DOORS | *80 CM. | IMPÑ4580 | IMPÑ6080 | |
| 2 PUERTAS 2DOORS | *90 CM. | IMPÑ4590 | IMPÑ6090 | |
| 2 PUERTAS 2DOORS | *100 CM. | IMPÑ4510 | IMPÑ6010 | |
| 2 PUERTAS 2DOORS | *120 CM. | IMPÑ4512 | IMPÑ6012 | |

*En las medidas 50/60/70/80/90/100/120 indicar si es portalavabo.

*INDICAR MANO DE APERTURA PUERTA : IZQUIERDA / DERECHA.

MÓDULO SUSPENDIDO DE DOS CAJONES.

SUSPENDED MODULE WITH TWO DRAWER.

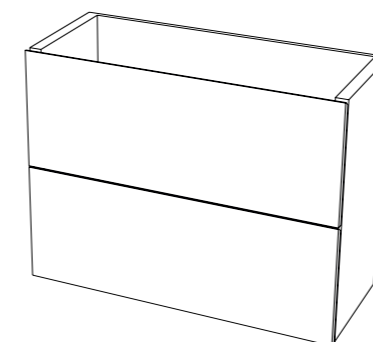

| ALTURA HEIGHT | ANCHURA WIDTH | CÓDIGO CODE | MATERIALES ADMITIDOS ADMITTED MATERIALS |
|------------------|------------------|----------------|--|
| 60 CM. | 30 CM. | IMTN6030 | |
| 60 CM. | 40 CM. | IMTN6040 | · LAMINADOS · LAMINATED |
| 60 CM. | *50 CM. | IMTN6050 | · DECOMAT · DECOMAT |
| 60 CM. | *60 CM | IMTN6060 | · FANTASIAS · FANTASIES |
| 60 CM. | *70 CM. | IMTN6070 | · LACA · LAQUERED |
| 60 CM. | *80 CM. | IMTN6080 | · CHAPA · LOCK |
| 60 CM. | *90 CM. | IMTN6090 | |
| 60 CM. | *100 CM. | IMTN6100 | |
| 60 CM. | *120 CM. | IMTN6120 | |

*En las medidas 50/60/70/80/90/100/120 indicar si debe llevar mecanizado para el sifón.

MÓDULO SUSPENDIDO DE UN CAJÓN.

SUSPENDED MODULE WITH ONE DRAWER.

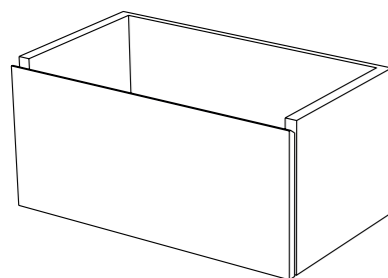

| ALTURA HEIGHT | ANCHURA WIDTH | CÓDIGO CODE | MATERIALES ADMITIDOS ADMITTED MATERIALS |
|------------------|------------------|----------------|--|
| 30 CM. | 30 CM. | IMTN3030 | |
| 40 CM. | 40 CM. | IMTN3040 | · LAMINADOS · LAMINATED |
| *50 CM. | *50 CM. | IMTN3050 | · DECOMAT · DECOMAT |
| *60 CM | *60 CM | IMTN3060 | · FANTASIAS · FANTASIES |
| *70 CM. | *70 CM. | IMTN3070 | · LACA · LAQUERED |
| *80 CM. | *80 CM. | IMTN3080 | · CHAPA · LOCK |
| *90 CM. | *90 CM. | IMTN3090 | |
| *100 CM. | *100 CM. | IMTN3100 | |
| *120 CM. | *120 CM. | IMTN3120 | |

*En las medidas 50/60/70/80/90/100/120 indicar si debe llevar mecanizado para el sifón.

MÓDULO SUSPENDIDO CON CAJÓN INTERIOR.

SUSPENDED MODULE WITH INTERIOR DRAWER.

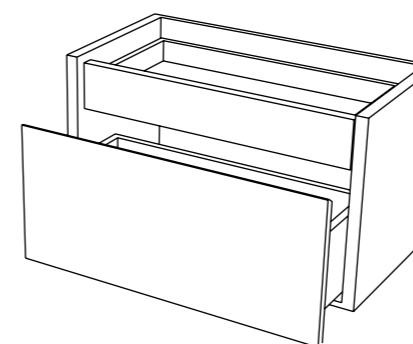

| ALTURA HEIGHT | ANCHURA WIDTH | CÓDIGO CODE | MATERIALES ADMITIDOS ADMITTED MATERIALS |
|------------------|------------------|----------------|--|
| 45 CM. | 30 CM. | IMTN4530 | |
| 45 CM. | 40 CM. | IMTN4540 | · LAMINADOS · LAMINATED |
| 45 CM. | *50 CM. | IMTN4550 | · DECOMAT · DECOMAT |
| 45 CM. | *60 CM | IMTN4560 | · FANTASIAS · FANTASIES |
| 45 CM. | *70 CM. | IMTN4570 | · LACA · LAQUERED |
| 45 CM. | *80 CM. | IMTN4580 | · CHAPA · LOCK |
| 45 CM. | *90 CM. | IMTN4590 | |
| 45 CM. | *100 CM. | IMTN4510 | |
| 45 CM. | *120 CM. | IMTN4512 | |

*En las medidas 50/60/70/80/90/100/120 indicar si debe llevar mecanizado para el sifón.



IMAGINA · Paris.

Sistema de apertura mecanizado en el propio frente sin necesidad de añadir un tirador físico.

Mechanized opening system on the front itself without the need to add a physical handle.

Mueble 1 cajón de 70 cm. der. negro mate. Mueble 2 cajones de 50 cm. izqu. Lavabo Thin desplazado izqu. Espejo Essential negro mate.

Furniture 1 drawer of 70 cm. right Matt black. Furniture 2 drawers of 50 cm. left Thin was-basin displaced left Matt black Essential mirror.

CÓDIGOS COMPOSICIÓN

· COMPOSITION CODES · IMPA3070 / IMPA6050 / LVTD1201 / ES070X110

MÓDULO DE 1/2 PUERTAS CON ESTANTE INTERIOR.

1/2 DOOR MODULE WITH INTERIOR SHELF.

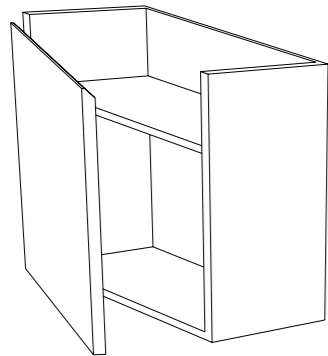

| | ANCHURA WIDTH | ALTO DE 45 HIGH 45 | ALTO DE 60 HIGH 60 | MATERIALES ADMITIDOS ADMITTED MATERIALS |
|------------------|------------------|-----------------------|-----------------------|--|
| 1 PUERTA 1DOOR | 30 CM. | IMP4530 | IMP6030 | |
| 1 PUERTA 1DOOR | 40 CM. | IMP4540 | IMP6040 | · LAMINADOS · LAMINATED |
| 1 PUERTA 1DOOR | *50 CM. | IMP4550 | IMP6050 | · DECOMAT · DECOMAT |
| 1 PUERTA 1DOOR | *60 CM | IMP4560 | IMP6060 | · FANTASIAS · FANTASIES |
| 2 PUERTAS 2DOORS | *60 CM | IMP4526 | IMP6026 | · LACA · LAQUERED |
| 2 PUERTAS 2DOORS | *70 CM. | IMP4570 | IMP6070 | · CHAPA · LOCK |
| 2 PUERTAS 2DOORS | *80 CM. | IMP4580 | IMP6080 | |
| 2 PUERTAS 2DOORS | *90 CM. | IMP4590 | IMP6090 | |
| 2 PUERTAS 2DOORS | *100 CM. | IMP4510 | IMP6100 | |
| 2 PUERTAS 2DOORS | *120 CM. | IMP4512 | IMP6120 | |

*En las medidas 50/60/70/80/90/100/120 indicar si es portalavabo.
*INDICAR MANO DE APERTURA PUERTA : IZQUIERDA / DERECHA.

MÓDULO SUSPENDIDO DE DOS CAJONES.

SUSPENDED MODULE WITH TWO DRAWER.

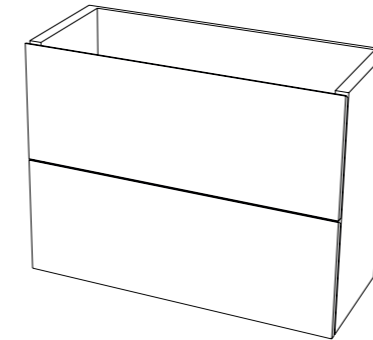

| ALTURA HEIGHT | ANCHURA WIDTH | CÓDIGO CODE | MATERIALES ADMITIDOS ADMITTED MATERIALS |
|------------------|------------------|----------------|--|
| 60 CM. | 30 CM. | IMPA6030 | |
| 60 CM. | 40 CM. | IMPA6040 | · LAMINADOS · LAMINATED |
| 60 CM. | *50 CM. | IMPA6050 | · DECOMAT · DECOMAT |
| 60 CM. | *60 CM | IMPA6060 | · FANTASIAS · FANTASIES |
| 60 CM. | *70 CM. | IMPA6070 | · LACA · LAQUERED |
| 60 CM. | *80 CM. | IMPA6080 | · CHAPA · LOCK |
| 60 CM. | *90 CM. | IMPA6090 | |
| 60 CM. | *100 CM. | IMPA6100 | |
| 60 CM. | *120 CM. | IMPA6120 | |

*En las medidas 50/60/70/80/90/100/120 indicar si debe llevar mecanizado para el sifón.

MÓDULO SUSPENDIDO DE UN CAJÓN.

SUSPENDED MODULE WITH ONE DRAWER.

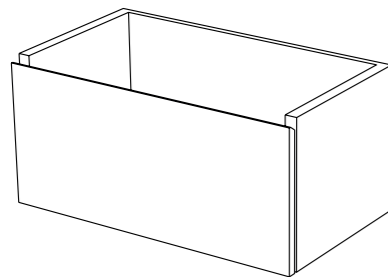

| ALTURA HEIGHT | ANCHURA WIDTH | CÓDIGO CODE | MATERIALES ADMITIDOS ADMITTED MATERIALS |
|------------------|------------------|----------------|--|
| 30 CM. | 30 CM. | IMPA3030 | |
| 40 CM. | 40 CM. | IMPA3040 | · LAMINADOS · LAMINATED |
| *50 CM. | *50 CM. | IMPA3050 | · DECOMAT · DECOMAT |
| *60 CM | *60 CM | IMPA3060 | · FANTASIAS · FANTASIES |
| *70 CM. | *70 CM. | IMPA3070 | · LACA · LAQUERED |
| *80 CM. | *80 CM. | IMPA3080 | · CHAPA · LOCK |
| *90 CM. | *90 CM. | IMPA3090 | |
| *100 CM. | *100 CM. | IMPA3100 | |
| *120 CM. | *120 CM. | IMPA3120 | |

*En las medidas 50/60/70/80/90/100/120 indicar si debe llevar mecanizado para el sifón.

MÓDULO SUSPENDIDO CON CAJÓN INTERIOR.

SUSPENDED MODULE WITH INTERIOR DRAWER.

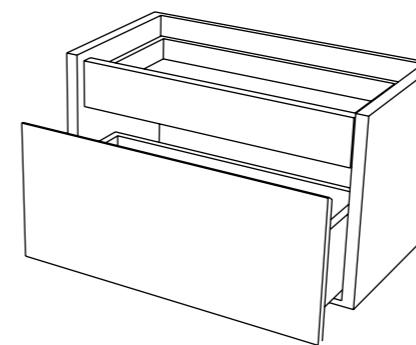

| ALTURA HEIGHT | ANCHURA WIDTH | CÓDIGO CODE | MATERIALES ADMITIDOS ADMITTED MATERIALS |
|------------------|------------------|----------------|--|
| 45 CM. | 30 CM. | IMMH4530 | |
| 45 CM. | 40 CM. | IMMH4540 | · LAMINADOS · LAMINATED |
| 45 CM. | *50 CM. | IMMH4550 | · DECOMAT · DECOMAT |
| 45 CM. | *60 CM | IMMH4560 | · FANTASIAS · FANTASIES |
| 45 CM. | *70 CM. | IMMH4570 | · LACA · LAQUERED |
| 45 CM. | *80 CM. | IMMH4580 | · CHAPA · LOCK |
| 45 CM. | *90 CM. | IMMH4590 | |
| 45 CM. | *100 CM. | IMMH4510 | |
| 45 CM. | *120 CM. | IMMH4512 | |

*En las medidas 50/60/70/80/90/100/120 indicar si debe llevar mecanizado para el sifón.



Jey · IMAGINA

IMAGINA · Uñero Jey.

Sistema de apertura mecanizado en el propio frente sin necesidad de añadir un tirador físico.
1 seno centrado. Espejo Minimal 120x80cm. Tapa sobre mueble 19 mm 120 Navarra arena.

Mechanized opening system on the front itself without the need to add a physical handle.
1 centered sinus. Minimal mirror 120x80cm. Top on furniture 19 mm 120 Navarra sand.

CÓDIGOS COMPOSICIÓN · COMPOSITION CODES : IMUJ3120 / IMUJ3060 / LVTHN120 / TSMLAM19 / MI080X120

MÓDULO DE 1/2 PUERTAS CON ESTANTE INTERIOR.

1/2 DOOR MODULE WITH INTERIOR SHELF.

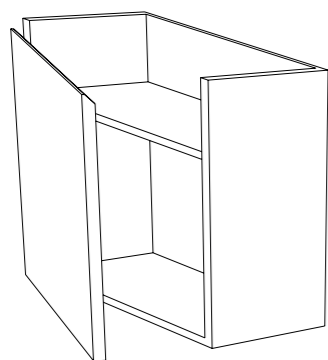

| | ANCHURA WIDTH | ALTO DE 45 HIGH 45 | ALTO DE 60 HIGH 60 | MATERIALES ADMITIDOS ADMITTED MATERIALS |
|------------------|------------------|-----------------------|-----------------------|--|
| 1 PUERTA 1DOOR | 30 CM. | IMPJ4530 | IMPJ60030 | |
| 1 PUERTA 1DOOR | 40 CM. | IMPJ4540 | IMPJ040 | · LAMINADOS · LAMINATED |
| 1 PUERTA 1DOOR | *50 CM. | IMPJ4550 | IMPJ6050 | · DECOMAT · DECOMAT |
| 1 PUERTA 1DOOR | *60 CM | IMPJ4560 | IMPJ6060 | · FANTASIAS · FANTASIES |
| 2 PUERTAS 2DOORS | *60 CM | IMPJ4626 | IMPJ6026 | · LACA · LAQUERED |
| 2 PUERTAS 2DOORS | *70 CM. | IMPJ4570 | IMPJ6070 | · CHAPA · LOCK |
| 2 PUERTAS 2DOORS | *80 CM. | IMPJ4580 | IMPJ6080 | |
| 2 PUERTAS 2DOORS | *90 CM. | IMPJ4590 | IMPJ6090 | |
| 2 PUERTAS 2DOORS | *100 CM. | IMPJ4510 | IMPJ6100 | |
| 2 PUERTAS 2DOORS | *120 CM. | IMPJ4512 | IMPJ6120 | |

*En las medidas 50/60/70/80/90/100/120 indicar si es portalavabo.

*INDICAR MANO DE APERTURA PUERTA : IZQUIERDA / DERECHA.

MÓDULO SUSPENDIDO DE DOS CAJONES.

SUSPENDED MODULE WITH TWO DRAWER.

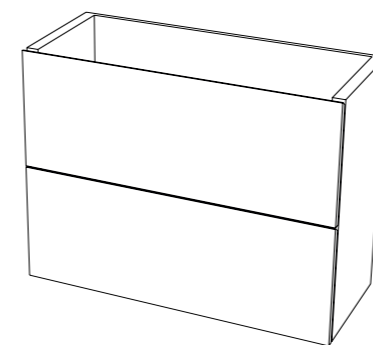

| ALTURA HEIGHT | ANCHURA WIDTH | CÓDIGO CODE | MATERIALES ADMITIDOS ADMITTED MATERIALS |
|------------------|------------------|----------------|--|
| 60 CM. | 30 CM. | IMUJ6030 | |
| 60 CM. | 40 CM. | IMUJ6040 | · LAMINADOS · LAMINATED |
| 60 CM. | *50 CM. | IMUJ6050 | · DECOMAT · DECOMAT |
| 60 CM. | *60 CM | IMUJ6060 | · FANTASIAS · FANTASIES |
| 60 CM. | *70 CM. | IMUJ6070 | · LACA · LAQUERED |
| 60 CM. | *80 CM. | IMUJ6080 | · CHAPA · LOCK |
| 60 CM. | *90 CM. | IMUJ6090 | |
| 60 CM. | *100 CM. | IMUJ6100 | |
| 60 CM. | *120 CM. | IMUJ6120 | |

*En las medidas 50/60/70/80/90/100/120 indicar si debe llevar mecanizado para el sifón.

MÓDULO SUSPENDIDO DE UN CAJÓN.

SUSPENDED MODULE WITH ONE DRAWER.

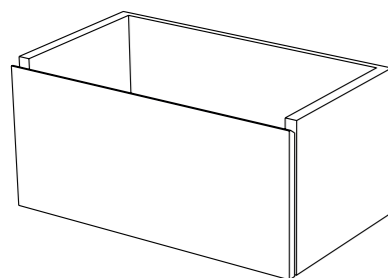

| ALTURA HEIGHT | ANCHURA WIDTH | CÓDIGO CODE | MATERIALES ADMITIDOS ADMITTED MATERIALS |
|------------------|------------------|----------------|--|
| 30 CM. | 30 CM. | IMUJ3030 | |
| 40 CM. | 40 CM. | IMUJ3040 | · LAMINADOS · LAMINATED |
| *50 CM. | *50 CM. | IMTÑ3050 | · DECOMAT · DECOMAT |
| *60 CM | *60 CM | IMUJ3060 | · FANTASIAS · FANTASIES |
| *70 CM. | *70 CM. | IMUJ3070 | · LACA · LAQUERED |
| *80 CM. | *80 CM. | IMUJ3080 | · CHAPA · LOCK |
| *90 CM. | *90 CM. | IMUJ3090 | |
| *100 CM. | *100 CM. | IMUJ3100 | |
| *120 CM. | *120 CM. | IMUJ3120 | |

*En las medidas 50/60/70/80/90/100/120 indicar si debe llevar mecanizado para el sifón.

MÓDULO SUSPENDIDO CON CAJÓN INTERIOR.

SUSPENDED MODULE WITH INTERIOR DRAWER.

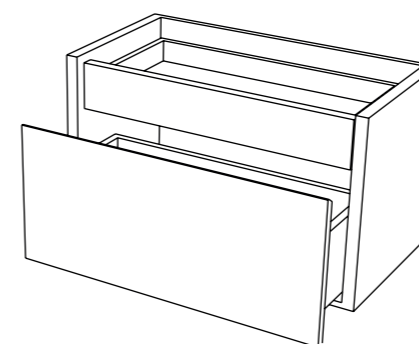

| ALTURA HEIGHT | ANCHURA WIDTH | CÓDIGO CODE | MATERIALES ADMITIDOS ADMITTED MATERIALS |
|------------------|------------------|----------------|--|
| 45 CM. | 30 CM. | IMUJ4530 | |
| 45 CM. | 40 CM. | IMUJ4540 | · LAMINADOS · LAMINATED |
| 45 CM. | *50 CM. | IMUJ4550 | · DECOMAT · DECOMAT |
| 45 CM. | *60 CM | IMUJ4560 | · FANTASIAS · FANTASIES |
| 45 CM. | *70 CM. | IMUJ4570 | · LACA · LAQUERED |
| 45 CM. | *80 CM. | IMUJ4580 | · CHAPA · LOCK |
| 45 CM. | *90 CM. | IMUJ4590 | |
| 45 CM. | *100 CM. | IMUJ4510 | |
| 45 CM. | *120 CM. | IMUJ4512 | |

*En las medidas 50/60/70/80/90/100/120 indicar si debe llevar mecanizado para el sifón.



IMAGINA · Push.

Sistema de apertura sin mecanizado que permite la apertura del cajón con una leve presión.
Opening system without machining that allows the opening of the drawer with a slight pressure.

Mueble portalavabo 1 cajón 60 cm. Roble Welles 2 UNID. Módulo decorativo de 60 vertical 2 huecos. Lavabo Libra desplazado izqu. 2 UNID. Espejo Minimal 40x100cm. Tapa sobre mueble 19 mm Roble welles.

Vanity unit with 1 drawer 60 cm. Oak Welles 2 UNIT. Decorative module of 60 vertical 2 holes. Libra washbasin displaced left 2 PCS. Minimal mirror 40x100cm. Top on furniture 19 mm Oak welles.

CÓDIGOS COMPOSICIÓN · COMPOSITION CODES · IMPS3060 / IMDB2630 / TSMLAM19 / MI040X100 / LVBLIBRA / TSMLAM19

MÓDULO DE 1/2 PUERTAS CON ESTANTE INTERIOR.

1/2 DOOR MODULE WITH INTERIOR SHELF.

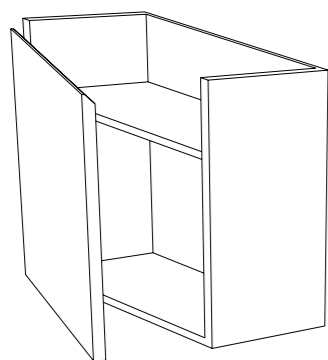

| | ANCHURA WIDTH | ALTO DE 45 HIGH 45 | ALTO DE 60 HIGH 60 | MATERIALES ADMITIDOS ADMITTED MATERIALS |
|------------------|------------------|-----------------------|-----------------------|--|
| 1 PUERTA 1DOOR | 30 CM. | IMPH4530 | IMPH6030 | |
| 1 PUERTA 1DOOR | 40 CM. | IMPH4540 | IMPH6040 | · LAMINADOS · LAMINATED |
| 1 PUERTA 1DOOR | *50 CM. | IMPH4550 | IMPH6050 | · DECOMAT · DECOMAT |
| 1 PUERTA 1DOOR | *60 CM | IMPH4560 | IMPH6060 | · FANTASIAS · FANTASIES |
| 2 PUERTAS 2DOORS | *60 CM | IMPH4526 | IMPH6026 | · LACA · LAQUERED |
| 2 PUERTAS 2DOORS | *70 CM. | IMPH4570 | IMPH6070 | · CHAPA · LOCK |
| 2 PUERTAS 2DOORS | *80 CM. | IMPH4580 | IMPH6080 | |
| 2 PUERTAS 2DOORS | *90 CM. | IMPH4590 | IMPH6090 | |
| 2 PUERTAS 2DOORS | *100 CM. | IMPH4510 | IMPH6100 | |
| 2 PUERTAS 2DOORS | *120 CM. | IMPH4520 | IMPH6120 | |

*En las medidas 50/60/70/80/90/100/120 indicar si es portalavabo.

*INDICAR MANO DE APERTURA PUERTA : IZQUIERDA / DERECHA.

MÓDULO SUSPENDIDO DE DOS CAJONES.

SUSPENDED MODULE WITH TWO DRAWER.

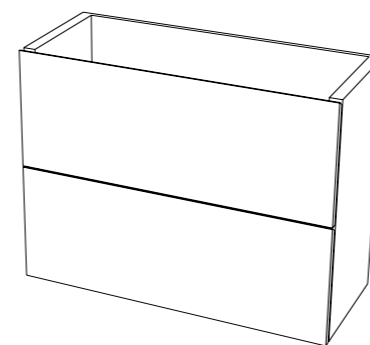

| ALTURA HEIGHT | ANCHURA WIDTH | CÓDIGO CODE | MATERIALES ADMITIDOS ADMITTED MATERIALS |
|------------------|------------------|----------------|--|
| 60 CM. | 30 CM. | IMPS6030 | |
| 60 CM. | 40 CM. | IMPS6040 | · LAMINADOS · LAMINATED |
| 60 CM. | *50 CM. | IMPS6050 | · DECOMAT · DECOMAT |
| 60 CM. | *60 CM | IMPS6060 | · FANTASIAS · FANTASIES |
| 60 CM. | *70 CM. | IMPS6070 | · LACA · LAQUERED |
| 60 CM. | *80 CM. | IMPS6080 | · CHAPA · LOCK |
| 60 CM. | *90 CM. | IMPS6090 | |
| 60 CM. | *100 CM. | IMPS6100 | |
| 60 CM. | *120 CM. | IMPS6120 | |

*En las medidas 50/60/70/80/90/100/120 indicar si debe llevar mecanizado para el sifón.

MÓDULO SUSPENDIDO DE UN CAJÓN.

SUSPENDED MODULE WITH ONE DRAWER.

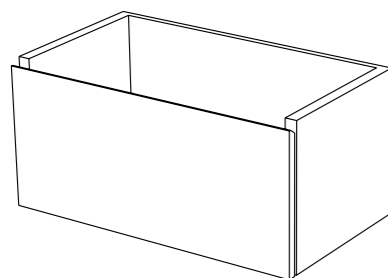

| ALTURA HEIGHT | ANCHURA WIDTH | CÓDIGO CODE | MATERIALES ADMITIDOS ADMITTED MATERIALS |
|------------------|------------------|----------------|--|
| 30 CM. | 30 CM. | IMPS3030 | |
| 40 CM. | 40 CM. | IMPS3040 | · LAMINADOS · LAMINATED |
| *50 CM. | *50 CM. | IMPS3050 | · DECOMAT · DECOMAT |
| *60 CM | *60 CM | IMPS3060 | · FANTASIAS · FANTASIES |
| *70 CM. | *70 CM. | IMPS3070 | · LACA · LAQUERED |
| *80 CM. | *80 CM. | IMPS3080 | · CHAPA · LOCK |
| *90 CM. | *90 CM. | IMPS3090 | |
| *100 CM. | *100 CM. | IMPS3100 | |
| *120 CM. | *120 CM. | IMPS3120 | |

*En las medidas 50/60/70/80/90/100/120 indicar si debe llevar mecanizado para el sifón.

MÓDULO SUSPENDIDO CON CAJÓN INTERIOR.

SUSPENDED MODULE WITH INTERIOR DRAWER.

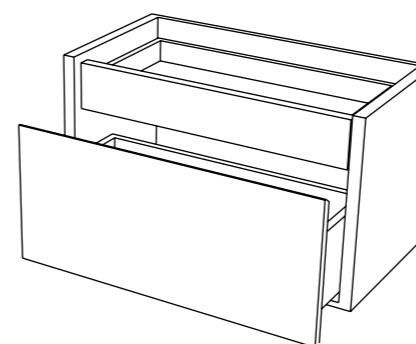

| ALTURA HEIGHT | ANCHURA WIDTH | CÓDIGO CODE | MATERIALES ADMITIDOS ADMITTED MATERIALS |
|------------------|------------------|----------------|--|
| 45 CM. | 30 CM. | IMSH4530 | |
| 45 CM. | 40 CM. | IMSH4540 | · LAMINADOS · LAMINATED |
| 45 CM. | *50 CM. | IMSH4550 | · DECOMAT · DECOMAT |
| 45 CM. | *60 CM | IMSH4560 | · FANTASIAS · FANTASIES |
| 45 CM. | *70 CM. | IMSH4570 | · LACA · LAQUERED |
| 45 CM. | *80 CM. | IMSH4580 | · CHAPA · LOCK |
| 45 CM. | *90 CM. | IMSH4590 | |
| 45 CM. | *100 CM. | IMSH4510 | |
| 45 CM. | *120 CM. | IMSH4512 | |

*En las medidas 50/60/70/80/90/100/120 indicar si debe llevar mecanizado para el sifón.

ACABADOS: LAMINADOS.

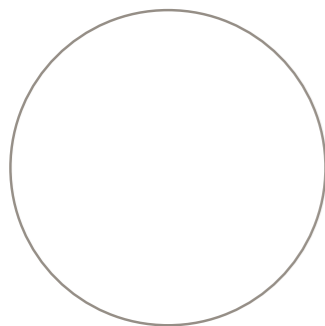

1.- BLANCO.



2.- HALIFAX.



3.- NOGAL TOSTADO.



4.- TRUFA.



5.- ROBLE WELLES.



6.- NAVARRA ARENA.



7.- NUDO.



8.- ZAYAN.



9.- CHESTER.



10.- HICKORY.



11.- ULMUS.

ACABADOS: DECOMAT.

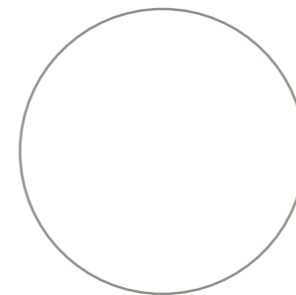

1.- BLANCO ALPINO.

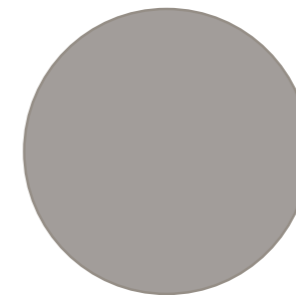

2.- ARCILLA.

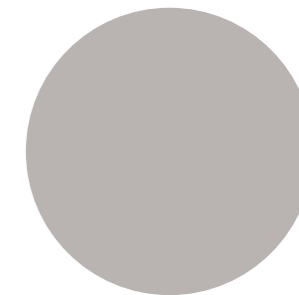

3.- CACHEMIRA.

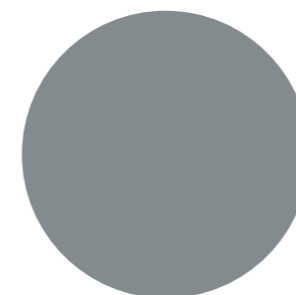

4.- MACADAN.

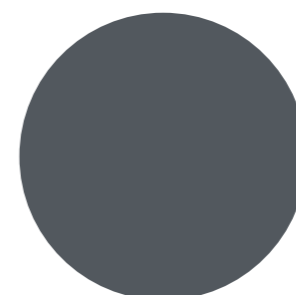

5.- GRAFITO.

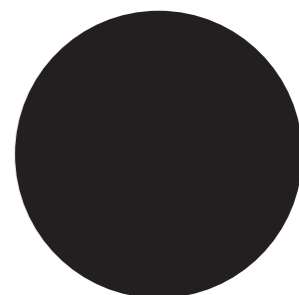

6.- BLACK.

FANTASIAS FANTASIES.



1.- BOTTEGA.

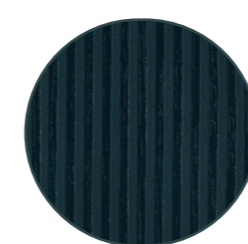

2.- RIGA.



3.- VULCANO.

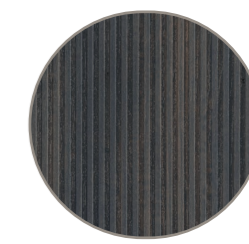

4.- LINE.

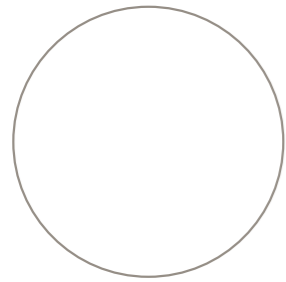

1.- BLANCO.



2.- BEIGE.

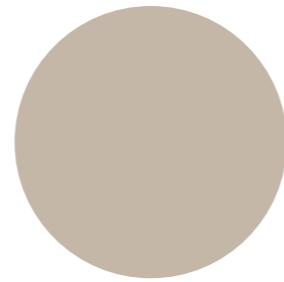

3.- ARENA.

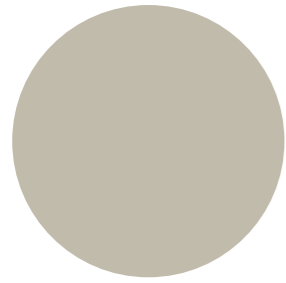

4.- SEPIA.

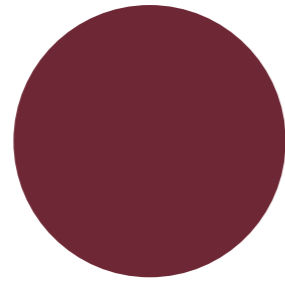

6.- BURDEOS

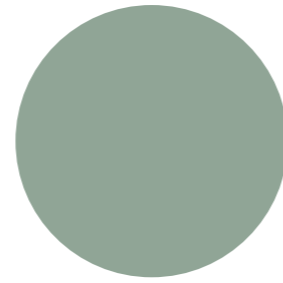

7.- OCEANO.

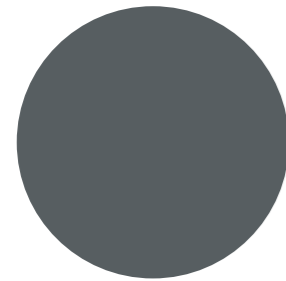

8.- MARENGO

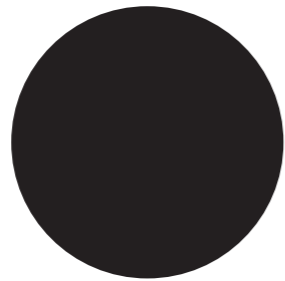

9.- NEGRO

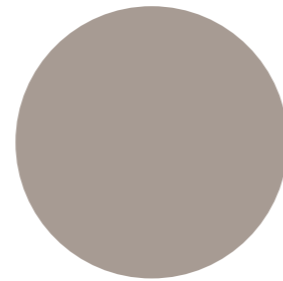

10.- VISON.

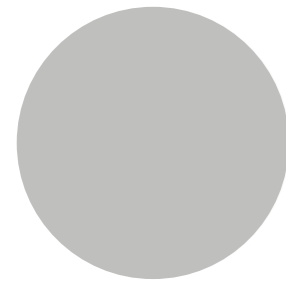

11.- GRIS.

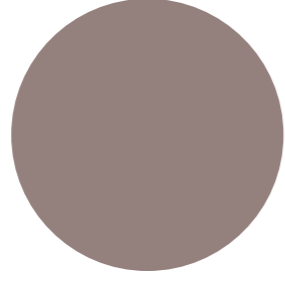

12.- MALEN

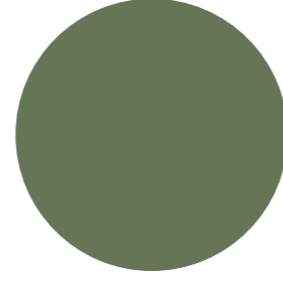

13.- VERDONE.

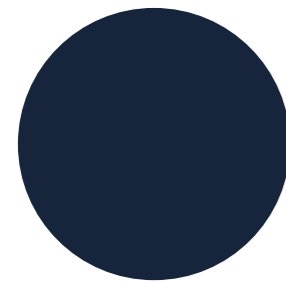

14.- AZUL.

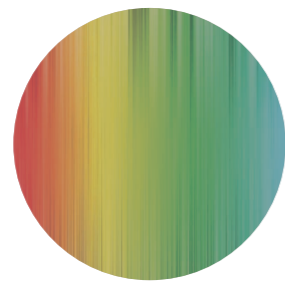

15.- RAL. *Incremento de un 25% segun tarifa.



1.- NOGAL.



2.- ROBLE.

* Las maderas naturales pueden presentar variaciones de veta.



LAVABOS WASHBASINS

Solid surface. 10 cm.

Encimera a medida de 10 cm con lavabo integrado.
Color blanco mate.

Material stoneacril selection.

Medidas del seno. 50 cm x 30 cm. profundidad de 12 cm.

Medidas máximas del lavabao. 200 cm.

El mecanizado para el grifo ira centrado en el seno, si no indican lo contrario.

Custom 10 cm countertop with integrated washbasin.

Matte white colour.

Stoneacryl selection material.

Breast measurements. 50cm x 30cm. depth of 12 cm.

Maximum measurements of the lavabao. 350 x 51 cm.

The machining for the faucet will be centered on the sinus, unless otherwise indicated.

min 60 cm. / max. 200 cm.

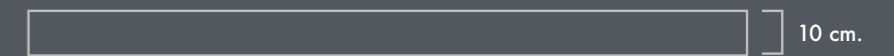
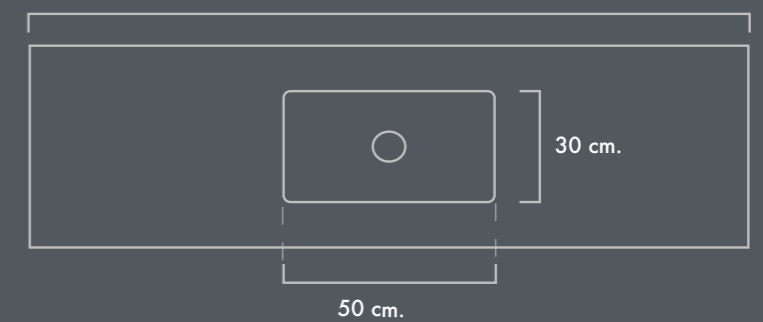

1 SENO CENTRADO CON FALDÓN DE 10
1 CENTERED BOWL WITH 10 SKIRT.

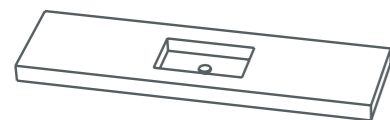

| ANCHURA WIDTH | CÓDIGO CODE |
|------------------|----------------|
| 60 | LVFS0060 |
| 70 | LVFS0070 |
| 80 | LVFS0080 |
| 90 | LVFS0090 |
| 100 | LVFS0100 |
| 110 | LVFS0110 |
| 120 | LVFS0120 |
| 130 | LVFS0130 |
| 140 | LVFS0140 |
| 150 | LVFS0150 |
| 160 | LVFS0160 |
| 170 | LVFS0170 |
| 180 | LVFS0180 |
| 190 | LVFS0190 |
| 200 | LVFS0200 |

1 SENO DESPLAZADO DERECHA CON FALDÓN DE 10
1 RIGHT OFFSET BOWL WITH 10 SKIRT

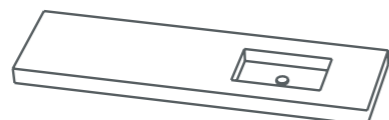

| ANCHURA WIDTH | CÓDIGO CODE |
|------------------|----------------|
| 90 | LVFS090D |
| 100 | LVFS100D |
| 110 | LVFS110D |
| 120 | LVFS120D |
| 130 | LVFS130D |
| 140 | LVFS140D |
| 150 | LVFS150D |
| 160 | LVFS160D |
| 170 | LVFS170D |
| 180 | LVFS180D |
| 190 | LVFS190D |
| 200 | LVFS200D |

1 SENO DESPLAZADO IZQUIERDA CON FALDÓN DE 10
1 LEFT OFFSET BOWL WITH 10 SKIRT

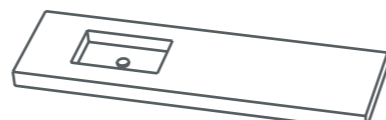

| ANCHURA WIDTH | CÓDIGO CODE |
|------------------|----------------|
| 90 | LVFS090I |
| 100 | LVFS100I |
| 110 | LVFS110I |
| 120 | LVFS120I |
| 130 | LVFS130I |
| 140 | LVFS140I |
| 150 | LVFS150I |
| 160 | LVFS160I |
| 170 | LVFS170I |
| 180 | LVFS180I |
| 190 | LVFS190I |
| 200 | LVFS200I |

SIN SENO CON FALDÓN DE 5
WITHOUT BOWL WITH SKIRT OF 5

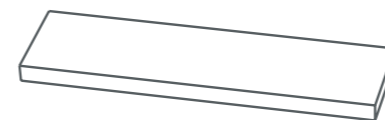

| ANCHURA WIDTH | CÓDIGO CODE |
|------------------|----------------|
| 60 | E05CF061 |
| 70 | E05CF071 |
| 80 | E05CF081 |
| 90 | E05CF091 |
| 100 | E05CF101 |
| 110 | E05CF111 |
| 120 | E05CF121 |
| 130 | E05CF131 |
| 140 | E05CF141 |
| 150 | E05CF151 |
| 160 | E05CF161 |
| 170 | E05CF171 |
| 180 | E05CF181 |
| 190 | E05CF191 |
| 200 | E05CF201 |

SIN SENO CON FALDÓN DE 10
WITHOUT BOWL WITH SKIRT OF 10



| ANCHURA WIDTH | CÓDIGO CODE |
|------------------|----------------|
| 60 | E10CF061 |
| 70 | E10CF071 |
| 80 | E10CF081 |
| 90 | E10CF091 |
| 100 | E10CF101 |
| 110 | E10CF111 |
| 120 | E10CF121 |
| 130 | E10CF131 |
| 140 | E10CF141 |
| 150 | E10CF151 |
| 160 | E10CF161 |
| 170 | E10CF171 |
| 180 | E10CF181 |
| 190 | E10CF191 |
| 200 | E10CF201 |

2 SENOS FALDÓN DE 10
2 SKIRT BOWLS OF 10

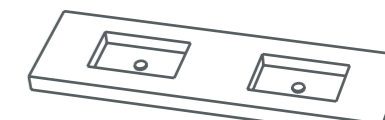

| ANCHURA WIDTH | CÓDIGO CODE |
|------------------|----------------|
| 120 | LVFS2120 |
| 130 | LVFS2130 |
| 140 | LVFS2140 |
| 150 | LVFS2150 |
| 160 | LVFS2160 |
| 170 | LVFS2170 |
| 180 | LVFS2180 |
| 190 | LVFS2190 |
| 200 | LVFS2200 |

***AÑADIR:**
2 escuadras (ref: ESCUADSS) hasta 130 seno centrado.
4 escuadras (ref: ESCUADSS) desde 130 a 200 seno centrado.
2 escuadras (ref: ESCUADSS) hasta 130 seno desplazado.
3 escuadras (ref: ESCUADSS) desde 130 a 200 seno desplazado.

*Pag. 159.

LAVABOS SOLID SURFACE · SOLID SURFACE WASHBASINS



LAVABOS

SOLID SURFACE. 1,2 cm.

Encimera a medida de 1,2 cm con lavabo integrado.
Color blanco mate.

Material stoneacril selection.

Medidas del seno. 50 cm x 30 cm. profundidad de 1,2 cm.

El mecanizado para el grifo ira centrado en el seno, si no indican lo contrario.

Countertop made to measure 1.2 cm with integrated sink.
White color.

Stoneacryl selection material.

Breast measurements. 50cm x 30cm. depth of 12 cm.

Maximum measurements of the lavabao. 200 X 60cm.

The machining for the faucet will be centered on the sinus, unless otherwise indicated.

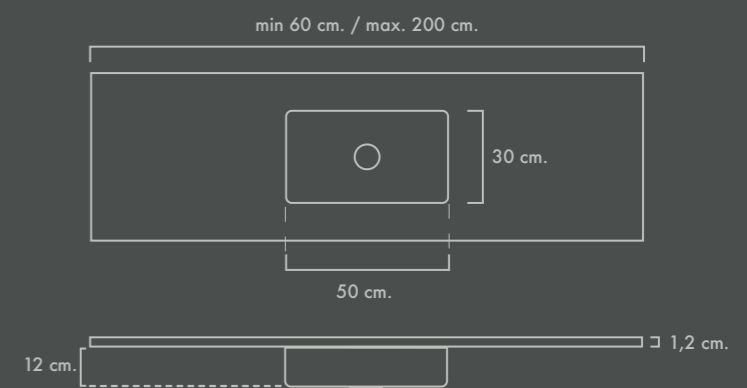

1 SENO CENTRADO CON FALDÓN DE 1,2
1 CENTERED BOWL WITH 1,2 SKIRT.

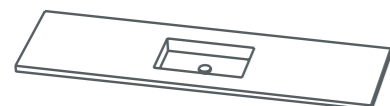

| ANCHURA WIDTH | CÓDIGO CODE |
|------------------|----------------|
| 60 | LVSS0060 |
| 70 | LVSS0070 |
| 80 | LVSS0080 |
| 90 | LVSS0090 |
| 100 | LVSS0100 |
| 110 | LVSS0110 |
| 120 | LVSS0120 |
| 130 | LVSS0130 |
| 140 | LVSS0140 |
| 150 | LVSS0150 |
| 160 | LVSS0160 |
| 170 | LVSS0170 |
| 180 | LVSS0180 |
| 190 | LVSS0190 |
| 200 | LVSS0200 |

1 SENO DESPLAZADO DERECHA CON FALDÓN DE 1,2
1 RIGHT OFFSET BOWL WITH 1,2 SKIRT



| ANCHURA WIDTH | CÓDIGO CODE |
|------------------|----------------|
| 90 | LVSS090D |
| 100 | LVSS100D |
| 110 | LVSS110D |
| 120 | LVSS120D |
| 130 | LVSS130D |
| 140 | LVSS140D |
| 150 | LVSS150D |
| 160 | LVSS160D |
| 170 | LVSS170D |
| 180 | LVSS180D |
| 190 | LVSS190D |
| 200 | LVSS200D |

1 SENO DESPLAZADO IZQUIERDA CON FALDÓN DE 1,2
1 LEFT OFFSET BOWL WITH 1,2 SKIRT



| ANCHURA WIDTH | CÓDIGO CODE |
|------------------|----------------|
| 90 | LVSS090I |
| 100 | LVSS100I |
| 110 | LVSS110I |
| 120 | LVSS120I |
| 130 | LVSS130I |
| 140 | LVSS140I |
| 150 | LVSS160I |
| 160 | LVSS150I |
| 170 | LVSS170I |
| 180 | LVSS180I |
| 190 | LVSS190I |
| 200 | LVSS200I |

SIN SENO CON FALDÓN DE 1,2
WITHOUT BOWL WITH SKIRT OF 1,2



| ANCHURA WIDTH | CÓDIGO CODE |
|------------------|----------------|
| 60 | E01SF061 |
| 70 | E01SF071 |
| 80 | E01SF081 |
| 90 | E01SF091 |
| 100 | E01SF101 |
| 110 | E01SF111 |
| 120 | E01SF121 |
| 130 | E01SF131 |
| 140 | E01SF141 |
| 150 | E01SF151 |
| 160 | E01SF161 |
| 170 | E01SF171 |
| 180 | E01SF181 |
| 190 | E01SF191 |
| 200 | E01SF201 |

2 SENOS FALDÓN DE 10
2 SKIRT BOWLS OF 10



| ANCHURA WIDTH | CÓDIGO CODE |
|------------------|----------------|
| 120 | LVSS2120 |
| 130 | LVSS2130 |
| 140 | LVSS2140 |
| 150 | LVSS2150 |
| 160 | LVSS2160 |
| 170 | LVSS2170 |
| 180 | LVSS2180 |
| 190 | LVSS2190 |
| 200 | LVSS2200 |

LAVABOS SOLID SURFACE 1,2 cm. SOLID SURFACE 1,2 cm.

LAVABOS
SOLID SURFACE. Ovalado.

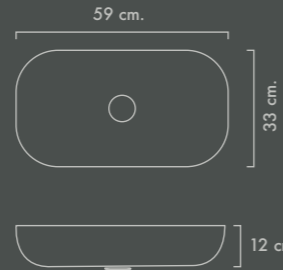

- Lavabo sobre encimera ovalado.
- Material stonacril selection.
- Color blanco.

LSSSEOVA

LAVABOS
SOLID SURFACE. Redondo

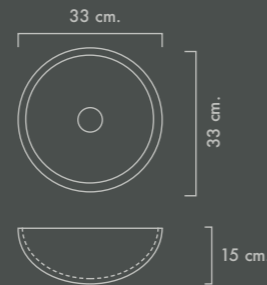

- Lavabo sobre encimera redondo.
- Material stonacril selection.
- Color blanco.

LSSSERED

LAVABOS
SOLID SURFACE. Rectangular.

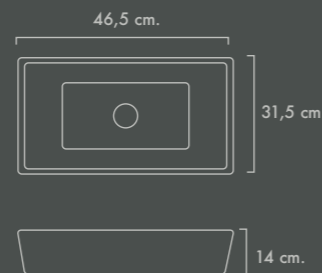
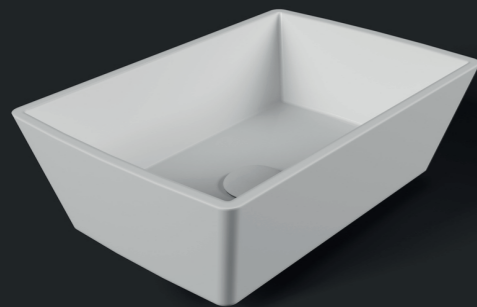

- Lavabo sobre encimera rectangular.
- Material stonacril selection.
- Color blanco.

LSSSRECE



LAVABOS
SOLID SURFACE. Toallero para faldón.

*Indicar opciones.

- FRONTAL.
- LAT DERECHO.
- LAT IZQUIERDO.

TOALFASS



LAVABOS
SOLID SURFACE. Toallero encimera.

TOALENSS

ESCUADRA DE SUJECIÓN. 1 und.

ESCUADSS



Agatha.

- Lavabo encastrado.
- Material resina con carga mineral.
- Colores solidos, metalizados y carta RAL.
- 2 cm de espesor.



Gio.

- Material resina con carga mineral.
- Recubrimiento antibacteriano.
- DISPONIBLE EN:
- Colores solidos · Metalizados
- Granito · Carta RAL.

LVBCZGIO

TARIFA & MEDIDAS. Agatha.

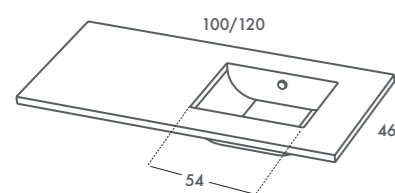

SENO DESPLAZADO A DERECHA SINE SHIFTED TO THE RIGHT

| | |
|-----|----------|
| 100 | LVAGDD10 |
| 120 | LVAGDD12 |

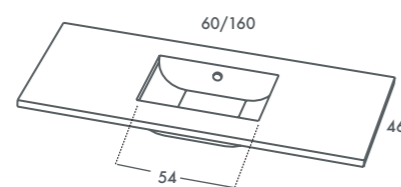

SENO CENTRADO CENTER SINES

| | |
|-----|----------|
| 60 | LVAGC060 |
| 70 | LVAGC070 |
| 80 | LVAGC080 |
| 90 | LVAGC090 |
| 100 | LVAGC100 |
| 120 | LVAGC120 |
| 140 | LVAGC140 |
| 160 | LVAGC160 |

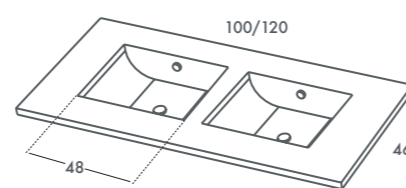

2 SENOS 2 SINES

| | |
|-----|----------|
| 120 | LVAG2120 |
|-----|----------|

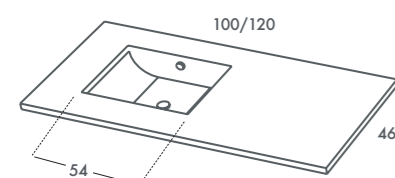

SENO DESPLAZADO A IZQUIERDA SINE SHIFTED TO THE LEFT

| | |
|-----|----------|
| 100 | LVAGDI10 |
| 120 | LVAGDI12 |

Acabados.

Colores sólidos.

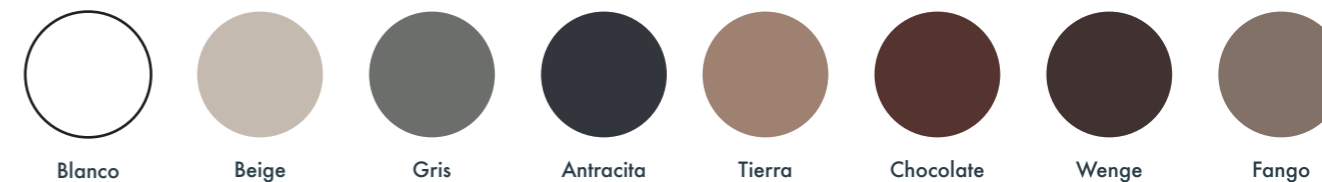

ADMITIDOS PARA MODELO: AGATHA, GIO, Y ENCIMERA DE 2 CM.

Colores metalizados.

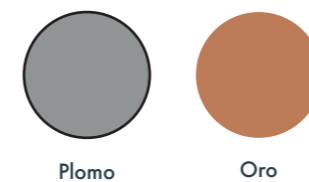

ADMITIDOS PARA MODELO:
AGHATA, GIO, Y ENCIMERA DE 2 CM.

Colores granito.



ADMITIDOS PARA MODELO:
GIO

*Posibilidad de pedir tanto el gio como el agatha segun carta ral o también con los colores de las lacas de catálogo.
INCREMENTO DE 100 Euros.



Thin.

- Lavabo encastrado.
- Con rebosadero.
- Porcelana blanca

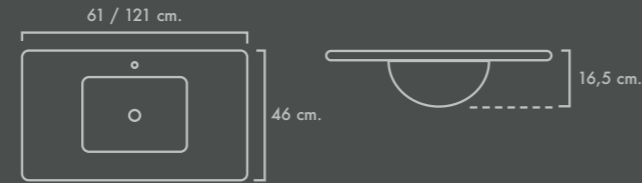

Nili Blanco mate.

- Lavabo sobre encimera circular.
- Material cerámica extrafina de 5 mm.
- Color blanco mate.

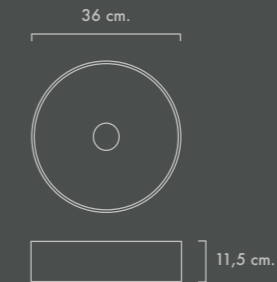

LVNILIBM

LAVABOS CERÁMICO Nili Blanco mate.

MEDIDAS MEASURES

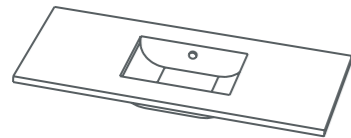

LAVABO ENCASTRAR
BUILT-IN WASHBASIN

| | |
|------------------|----------|
| 61 x 46 | LVTHN060 |
| 71 x 46 | LVTHN070 |
| 81 x 46 | LVTHN080 |
| 91 x 46 | LVTHN090 |
| 101 x 46 | LVTHN100 |
| 121 x 46 1 seno | LVTHN120 |
| 121 x 46 2 senos | LVTH2120 |

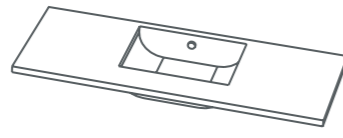

LAVABO ENCASTRAR
FONDO REDUCIDO 39,5 CM
BUILT-IN WASHBASIN
REDUCED DEPTH 39.5 CM.

| | |
|------------|----------|
| 61 x 39,5 | LVTFR060 |
| 71x39,5 | LVTFR070 |
| 81 x 39,5 | LVTFR080 |
| 91 x 39,5 | LVTFR090 |
| 101 x 39,5 | LVTFR100 |

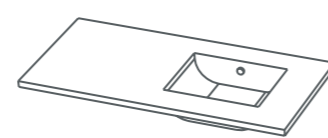

LAVABO ENCASTRAR
DESPLAZADO DERECHA
BUILT-IN WASHBASIN
OFFSET RIGHT

| | |
|-----------------|----------|
| 91 x 46 | LVTD090D |
| 101 x 46 | LVTD100D |
| 121 x 46 1 seno | LVTD120D |

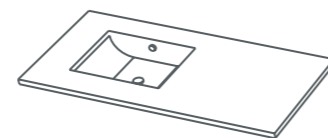

LAVABO ENCASTRAR
DESPLAZADO IZQUIERDA
BUILT-IN WASHBASIN
OFFSET LEFT

| | |
|-----------------|----------|
| 91 x 46 | LVTD090I |
| 101 x 46 | LVTD100I |
| 121 x 46 1 seno | LVTD120I |



Nili Negro mate.

- Lavabo sobre encimera circular.
- Material cerámica extrafina de 5 mm.
- Color negro mate.

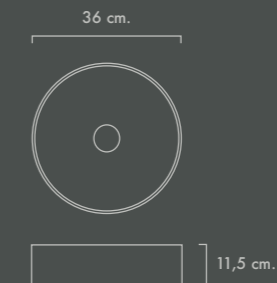

LVNILINM

LAVABOS CERÁMICO Nili Negro mate.



Cilin blanco brillo.

- Lavabo sobre encimera circular.
- Material cerámica extrafina de 5 mm.
- Color blanco brillo.

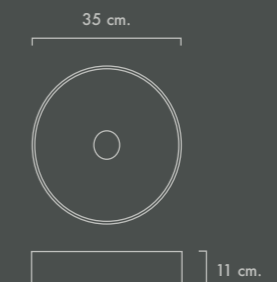

LVBOCILIN

LAVABOS CERÁMICO Cilin Blanco brillo.



LAVABOS CERÁMICO Monaco

Monaco.

- Lavabo sobre encimera ovalado.
- Material Porcelana blanca
- Color blanco brillo.

49 cm.

42,5 cm.

11,5 cm.

LVMONACO



LAVABOS CERÁMICO Fino SQ36.

Fino SQ36.

- Lavabo sobre encimera rectangular.
- Material cerámica extrafina de 5 mm.
- Color blanco brillo.

36 cm.

12 cm.

LVBOSQ36



LAVABOS CERÁMICO Nova.

Nova.

- Lavabo sobre encimera rectangular.
- Material porcelana blanca.
- Color blanco brillo.

58,5 cm.

36,5 cm.

10 cm.

LVBNOVA



LAVABOS CERÁMICO Oval.

Oval.

- Lavabo sobre encimera circular.
- Material cerámica extrafina de 5 mm.
- Color negro mate.

49 cm.

30 cm.

13 cm.

LVBOOVAL



LAVABOS CERÁMICO Leon.

Leon.

- Lavabo sobre encimera rectangular.
- Material porcelana blanca.
- Color blanco brillo.

50 cm.

12 cm.

LVBOLEON



LAVABOS CERÁMICO Libra.

Libra.

- Lavabo sobre encimera cuadrado.
- Con rebosadero.
- Material porcelana blanca.
- Color blanco brillo.

41 cm.

12 cm.

LVBLIBRA



LAVABOS
GEA MARMOL.

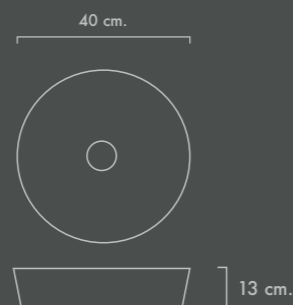

Gea marmol.

- Lavabo sobre encimera circular.
- Material marmol sin rebosadero.

LVBOGEAN



FURNAS NEGRO MATE.

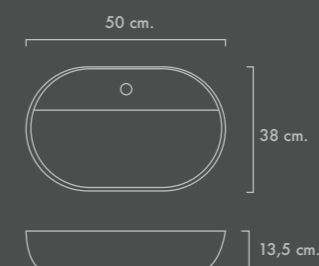

Furnan.

- Lavabo sobre encimera ovalado.
- Sin rebosadero.
- Acabado brillo.

LVFURNAN



LAVABOS
AKUTAN PIEDRA.

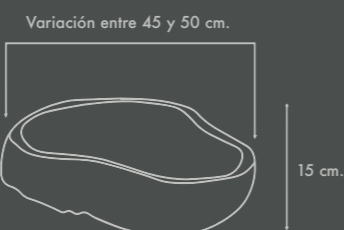

Akutan piedra.

- Lavabo sobre encimera sin rebosadero.
- Material piedra natural.
- Las medidas, texturas y formas de estos lavabos pueden variar.

LVAKUTAN



FURNAS BLANCO MATE.

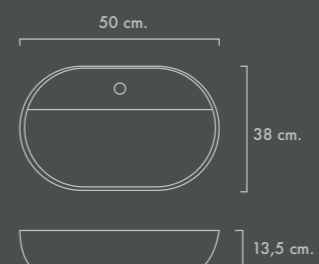

Furnab.

- Lavabo sobre encimera ovalado.
- Sin rebosadero.
- Acabado brillo.

LVFURNAB

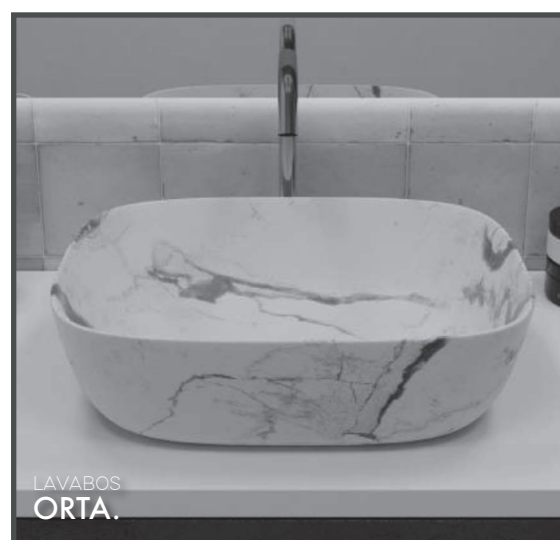

LAVABOS
ORTA.

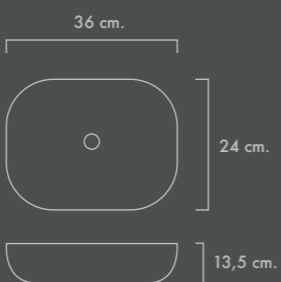

Orta.

- Lavabo sobre encimera sin rebosadero.
- Material cerámica mate.
- Las medidas, texturas y formas de estos lavabos pueden variar.

LVBOORTA



ISEO.

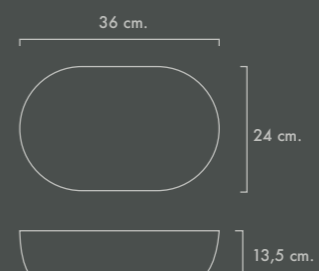

Iseo.

- Lavabo sobre encimera sin rebosadero.
- Material cerámica mate.
- Las medidas, texturas y formas de estos lavabos pueden variar.

LVBOISEO

COMPLEMENTOS · Espejos.

COMPLEMENTOS · Espejos.

El espejo es el gran aliado de tu baño, se convierte en el fiel reflejo de este con la importancia de poder dar amplitud a un espacio reducido o jugar con las combinaciones de luces o marcos generando un amplio abanico de posibilidades.

The mirror is the great ally of your bathroom, it becomes the faithful reflection of it with the importance of being able to give amplitude to a small space or play with the combinations of lights or frames generating a wide range of possibilities.



ESPEJO REDONDO ACABADO ORO · GOLD FINISH ROUND MIRROR

- ESPEJO REDONDO CON BORDE PINTADO EN ORO DE 3 CM
- ROUND MIRROR WITH EDGE PAINTED IN GOLD OF 3 CM
- DISPONIBILIDAD DE RETROILUMINACIÓN
- ROUND MIRROR WITH EDGE PAINTED IN GOLD OF 3 CM
- BACKLIGHT AVAILABILITY

ESPEJO SIN RETROILUMINACIÓN
NON-BACKLIGHTED MIRROR

| | |
|-----|-----------------|
| 60 | ESROR60L |
| 80 | ESROR80L |
| 100 | ESROR10L |

ESPEJO RETROILUMINADO
BACKLIGHTED MIRROR

| | |
|-----|-----------------|
| 60 | ESRDOR60 |
| 80 | ESRDOR80 |
| 100 | ESRDOR10 |



ESPEJO REDONDO ACABADO NEGRO · BLACK FINISH ROUND MIRROR

- ESPEJO REDONDO CON BORDE PINTADO EN NEGRO DE 3 CM
- ROUND MIRROR WITH EDGE PAINTED IN BLACK OF 3 CM
- DISPONIBILIDAD DE RETROILUMINACIÓN
- BACKLIGHT AVAILABILITY

ESPEJO SIN RETROILUMINACIÓN
NON-BACKLIGHTED MIRROR

| | |
|-----|-----------------|
| 60 | ESRNE60L |
| 80 | ESRNE80L |
| 100 | ESRNE10L |

ESPEJO RETROILUMINADO
BACKLIGHTED MIRROR

| | |
|-----|-----------------|
| 60 | ESRDNE60 |
| 80 | ESRDNE80 |
| 100 | ESRDNE10 |



Espejo ovalado borde pintado
Oval mirror painted edge

Varios colores disponibles para el marco
Various colors available for the frame

Disponibilidad de retroiluminación
Backlight availability

Medidas · Measures.
50 x 90 cm.



MARCO NEGRO.
BLACK EDGE.

ESPEJO SIN RETROILUMINACIÓN
NON-BACKLIGHTED MIRROR

ESOVMN59

ESPEJO RETROILUMINADO
BACKLIGHTED MIRROR

ESOVRN59



MARCO ORO.
GOLD EDGE.

ESPEJO SIN RETROILUMINACIÓN
NON-BACKLIGHTED MIRROR

ESOVMO59

ESPEJO RETROILUMINADO
BACKLIGHTED MIRROR

ESOVRO59



MARCO ACIDO.
ACID EDGE.

ESPEJO SIN RETROILUMINACIÓN
NON-BACKLIGHTED MIRROR

ESOVMA59

ESPEJO RETROILUMINADO
BACKLIGHTED MIRROR

ESOVRA59

Minimal.

- Espejo sin tablero.
- Anclaje a pared en vertical y en horizontal.
- Mirror without board.
- Wall anchoring vertically and horizontally.

| MEDIDA | CÓDIGO | MEDIDA | CÓDIGO | MEDIDA | CÓDIGO |
|--------|----------|--------|----------|--------|----------|
| 80X100 | MI080100 | 60X80 | MI06080 | 80X120 | MI080120 |
| 70X110 | MI070110 | 70X80 | MI07080 | 80X140 | MI080140 |
| 40X100 | MI040100 | 80X80 | MI08080 | 80X160 | MI080160 |
| 40X120 | MI040120 | 80X90 | MI08090 | | |
| 60X120 | MI060120 | 70X100 | MI070100 | | |

Essential.

- Espejo con tablero.
- Acabados: Laca, Laminado, Decomat, Fantasia, Chapa.
- Finishes: Laquered, laminated and decomat.
- Mirror without board.
- Wall anchoring vertically and horizontally.

| MEDIDA | CÓDIGO | MEDIDA | CÓDIGO | MEDIDA | CÓDIGO |
|--------|----------|--------|----------|--------|----------|
| 60X80 | ES06080 | 80X100 | ES080100 | 80X120 | ES080120 |
| 70X80 | ES07080 | 70X110 | ES070110 | 80X140 | ES080140 |
| 80X80 | ES08080 | 40X100 | ES040100 | 80X160 | ES080160 |
| 80X90 | ES08090 | 40X120 | ES040120 | | |
| 70X100 | ES070100 | 60X120 | ES060120 | | |

*EL PRECIO ES EL MISMO PARA TODOS LOS ACABADOS DEL TABLERO QUE CONFORMA EL ESPEJO.
*THE PRICE IS THE SAME FOR ALL THE FINISHES OF THE PANEL THATMAKES UP THE MIRROR.

Elegance.

- Espejo con marco.
- Acabados: Laca, Laminado, Decomat, Fantasia, Chapa.
- Finishes: Lacquer, Laminated, Decomat, Fantasia, Veneer.
- Mirror with board.

| MEDIDA | CÓDIGO | MEDIDA | CÓDIGO | MEDIDA | CÓDIGO |
|--------|----------|--------|----------|--------|----------|
| 60X80 | EL06080 | 80X100 | EL080100 | 80X120 | EL080120 |
| 70X80 | EL07080 | 70X110 | EL070110 | 80X140 | EL080140 |
| 80X80 | EL08080 | 40X100 | EL040100 | 80X160 | EL080160 |
| 80X90 | EL08090 | 40X120 | EL040120 | | |
| 70X100 | EL070100 | 60X120 | EL060120 | | |

*EL PRECIO ES EL MISMO PARA TODOS LOS ACABADOS DEL TABLERO QUE CONFORMA EL ESPEJO.
*THE PRICE IS THE SAME FOR ALL THE FINISHES OF THE PANEL THATMAKES UP THE MIRROR.

ELEGANCE
100 X 80



ELEGANCE
80 X 100

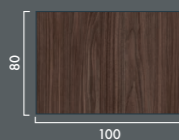

LA MALLA DE LA MADERA IRÁ SIEMPRE EN LA DIRECCIÓN DE LA MEDIDA.

Redondo.

- Espejo redondo sin marco.
- Round frameless mirror.

| MEDIDA | CÓDIGO |
|--------|----------|
| 60 | ESRSM060 |
| 80 | ESRSM080 |
| 90 | ESRSM090 |

Redondo. Marco negro.

- Espejo redondo con marco.
- Round frameless mirror.

| MEDIDA | CÓDIGO |
|--------|----------|
| 60 | ESRNE060 |
| 80 | ESRNE080 |
| 90 | ESRNE090 |

Redondo. Marco dorado.

- Espejo redondo con marco.
- Round frameless mirror.

| MEDIDA | CÓDIGO |
|--------|----------|
| 60 | ESRDO060 |
| 80 | ESRDO080 |
| 90 | ESRDO090 |

Acabados.

Lacados./Laquered.



Laminados./Laminated.

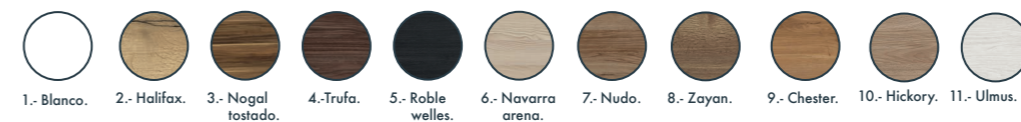

Decomat./Decomat.



Fantasias / Fantasies.



Chapa natural./ Natural veneer.





Iluminación LED.
Perimetral espejo cuadrado.

· Luz LED 4.8 W. · EFICIENCIA A+.
· 4000 K.

Minimal.

| MEDIDA | CÓDIGO |
|--------|----------|
| 60x80 | LEDPE068 |
| 70x80 | LEDPE078 |
| 80x80 | LEDPE88 |
| 90x80 | LEDPE098 |
| 40x100 | LEDPE410 |

| MEDIDA | CÓDIGO |
|--------|----------|
| 70x100 | LEDPE710 |
| 80x100 | LEDPE810 |
| 70x110 | LEDPE711 |
| 40x120 | LEDPE412 |
| 60x120 | LEDPE612 |

| MEDIDA | CÓDIGO |
|--------|----------|
| 80x120 | LEDPE812 |
| 80x140 | LEDPE814 |
| 80x160 | LEDPE816 |



Iluminación LED.
Inferior y superior.

· Luz LED 4.8 W. · EFICIENCIA A+.
· 4000 K.

Minimal & Essential.

| MEDIDA | CÓDIGO |
|--------|-----------|
| 40x40 | LEDDIS040 |
| 60x60 | LEDDIS060 |
| 70x70 | LEDDIS070 |
| 80x80 | LEDDIS080 |
| 90x90 | LEDDIS090 |

| MEDIDA | CÓDIGO |
|---------|-----------|
| 100x100 | LEDDIS100 |
| 110x110 | LEDDIS110 |
| 120x120 | LEDDIS120 |
| 140x140 | LEDDIS140 |
| 160x160 | LEDDIS160 |



Iluminación LED.
Laterales.

· Luz LED 4.8 W. · EFICIENCIA A+.
· 4000 K.

Minimal & Essential.

| MEDIDA | CÓDIGO |
|--------|----------|
| 40x40 | LEDDI040 |
| 60x60 | LEDDI060 |
| 70x70 | LEDDI070 |
| 80x80 | LEDDI080 |
| 90x90 | LEDDI090 |

| MEDIDA | CÓDIGO |
|---------|----------|
| 100x100 | LEDDI100 |
| 110x110 | LEDDI110 |
| 120x120 | LEDDI120 |
| 140x140 | LEDDI140 |
| 160x160 | LEDDI160 |



Iluminación LED.
Perimetral espejo redondo.

· Luz LED 4.8 W. · EFICIENCIA A+.
· 4000 K.

Redondo. Sin marco.

Redondo Sin Marco
Tarifa LED. · Perimetral.

| MEDIDA | CÓDIGO |
|--------|----------|
| 60 | LEDER060 |
| 80 | LEDER080 |
| 90 | LEDER090 |



Plexi300.

- Aplique instalado en la parte superior del espejo.
- Acabado cromado brillante.

| MEDIDA | CÓDIGO |
|--------|----------|
| 30 | PLEXI300 |

- Luz LED 4.8 W. · EFICIENCIA A+
- 4000 K.



Plexi450.

- Aplique instalado en la parte superior del espejo.
- Acabado cromado brillante.

| MEDIDA | CÓDIGO |
|--------|----------|
| 45 | PLEXI450 |

- Luz LED 4.8 W. · EFICIENCIA A+
- 4000 K.



Plexi600.

- Aplique instalado en la parte superior del espejo.
- Acabado cromado brillante.

| MEDIDA | CÓDIGO |
|--------|----------|
| 60 | PLEXI600 |

- Luz LED 4.8 W. · EFICIENCIA A+
- 4000 K.



Lex Aplique negro.

- Aplique instalado en la parte superior del espejo.
- Acabado negro.

| MEDIDA | CÓDIGO |
|--------|----------|
| 45 | LEXNE450 |

- Luz LED 4.8 W. · EFICIENCIA A+
- 4000 K.



Ito570.

- Aplique a pared
- Acabado cromado negro.
- Medida: largo 57 cm.

| MEDIDA | CÓDIGO |
|--------|----------|
| 57 | ITO570NE |

- Luz LED 6,7W/20,9W. · EFICIENCIA A+
- 3000 K.



Tis.

- Luz colgante.
- Acabado cromado negro.
- Estructura de acero.
- Medidas lampara: 10x30cm.
- Medida total: 132 x 100 cm.

| MEDIDA | CÓDIGO |
|--------|----------|
| 30 | TISTECNE |

- Luz 9W. · EFICIENCIA A+
- 3000 K.



Sit.

- Luz para instalación en pared
- Acabado cromado negro.
- Estructura de acero.
- Medidas total: 10x21cm.

| MEDIDA | CÓDIGO |
|--------|----------|
| 21 | SITPARNE |

- Luz 9W. · EFICIENCIA A+
- 3000K



COMPLEMENTOS · Estanterías.

El complemento ideal para tu baño.
Módulos para poder combinar de la manera que más te guste.
Módulo abierto.
Módulo con puerta apertura PUSH.

COMPLEMENTS · Shelves.

The ideal complement for your bathroom.
Modules to be able to combine the way you like.
Open module.
Module with PUSH opening door.

Estantería con puerta de 40 · Shelving with door of 30.

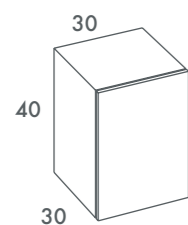

Mod. ESTP004D/ESTP0040I
 PUERTA MALLA VERTICAL VERTICAL MESH DOOR.

ADMITE :
 · LAMINADO · DECOMAT · FANTASIA · LACADO · CHAPA NATURAL.
 ADMITTED :
 · LAMINATE · DECOMAT · FANTASY · LACQUERED · NATURAL PLATE.

EN EL PEDIDO DEBERÁ ESPECIFICAR LA MANO DE APERTURA.

Estantería sin puerta de 40 · Shelving with door of 30.

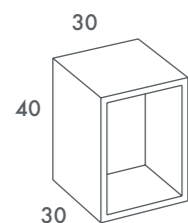

Mod. ESTH0040

ADMITE :
 · LAMINADO · DECOMAT · FANTASIA · LACADO · CHAPA NATURAL.
 ADMITTED :
 · LAMINATE · DECOMAT · FANTASY · LACQUERED · NATURAL PLATE.

Estantería 1 estante con puerta de 80 · Shelving with door of 80, 1 shelf.

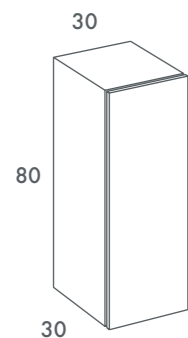

Mod. ESTP0080D/ESTP0080I
 PUERTA MALLA VERTICAL VERTICAL MESH DOOR.

ADMITE :
 · LAMINADO · DECOMAT · FANTASIA · LACADO · CHAPA NATURAL.
 ADMITTED :
 · LAMINATE · DECOMAT · FANTASY · LACQUERED · NATURAL PLATE.

EN EL PEDIDO DEBERÁ ESPECIFICAR LA MANO DE APERTURA.

Estantería 1 estante sin puerta de 80 · Shelf 1 shelf without door of 80

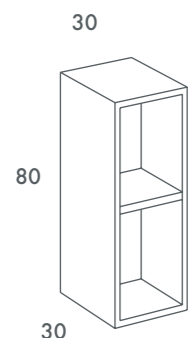

Mod. ESTP0080D/ESTP0080I

ADMITE :
 · LAMINADO · DECOMAT · FANTASIA · LACADO · CHAPA NATURAL.
 ADMITTED :
 · LAMINATE · DECOMAT · FANTASY · LACQUERED · NATURAL PLATE.

Estantería 2 estantes con puerta de 120 · Shelving with door of 120 2 shelf

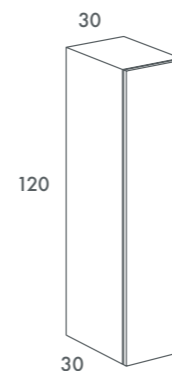

Mod. ESTH0120D/ESTH0120I
 PUERTA MALLA VERTICAL VERTICAL MESH DOOR.

ADMITE :
 · LAMINADO · DECOMAT · FANTASIA · LACADO · CHAPA NATURAL.
 ADMITTED :
 · LAMINATE · DECOMAT · FANTASY · LACQUERED · NATURAL PLATE.

EN EL PEDIDO DEBERÁ ESPECIFICAR LA MANO DE APERTURA.

Estantería 2 estante sin puerta de 120 · Shelf 2 shelf without door of 120

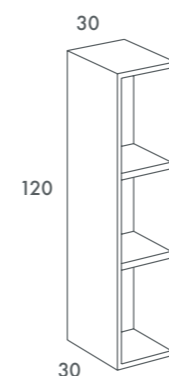

Mod. ESTP0080D/ESTP0080I

ADMITE :
 · LAMINADO · DECOMAT · FANTASIA · LACADO · CHAPA NATURAL.
 ADMITTED :
 · LAMINATE · DECOMAT · FANTASY · LACQUERED · NATURAL PLATE.

Estantería 3 estantes con puerta de 160 · Shelving with door of 160 3 shelf.

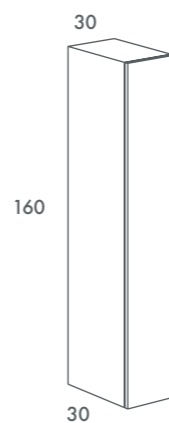

Mod. ESTH0160D/ESTH0160I
 PUERTA MALLA VERTICAL VERTICAL MESH DOOR.

ADMITE :
 · LAMINADO · DECOMAT · FANTASIA · LACADO · CHAPA NATURAL.
 ADMITTED :
 · LAMINATE · DECOMAT · FANTASY · LACQUERED · NATURAL PLATE.

EN EL PEDIDO DEBERÁ ESPECIFICAR LA MANO DE APERTURA.

Estantería 3 estante sin puerta de 160 · Shelf 3 shelf without door of 160

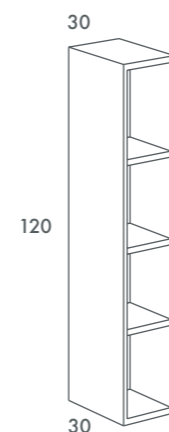

Mod. ESTP0160D/ESTP0160I

ADMITE :
 · LAMINADO · DECOMAT · FANTASIA · LACADO · CHAPA NATURAL.
 ADMITTED :
 · LAMINATE · DECOMAT · FANTASY · LACQUERED · NATURAL PLATE.



COMPLEMENTOS · Módulos decorativos.

Dale un toque personal a tu mueble.
Combinalo con nuestros módulos decorativos permitiendo obtener la composición que más te guste.
Dale dinamismo y personalidad a tu cuarto de baño.

COMPLEMENTS · Decorative modules.

Give a personal touch to your furniture.
Combine it with our decorative modules allowing you to obtain the composition that you like the most.
Give dynamism and personality to your bathroom.

Mueble bajo de 30 · Base unit of 30

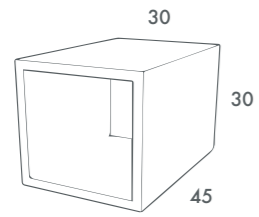

| CÓDIGO CODE | ANCHURA WIDTH |
|----------------|------------------|
| IMDB1330 | 30 |
| IMDB1340 | 40 |
| IMDB1350 | 50 |
| IMDB1360 | 60 |

ADMITE :
· LAMINADO · DECOMAT · FANTASIA · LACADO · CHAPA NATURAL.
ADMITTED :
· LAMINATE · DECOMAT · FANTASY · LACQUERED · NATURAL PLATE.

Mueble bajo de 45 · Base unit of 45

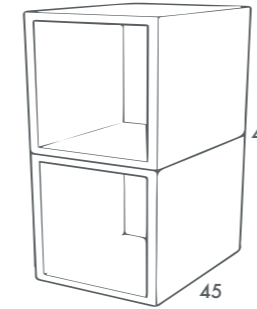

| CÓDIGO CODE | ANCHURA WIDTH |
|----------------|------------------|
| IMDB2420 | 20 |
| IMDB2430 | 30 |
| IMDB2440 | 40 |
| IMDB2450 | 50 |

ADMITE :
· LAMINADO · DECOMAT · FANTASIA · LACADO · CHAPA NATURAL.
ADMITTED :
· LAMINATE · DECOMAT · FANTASY · LACQUERED · NATURAL PLATE.

Mueble bajo de 60 · Base unit of 60

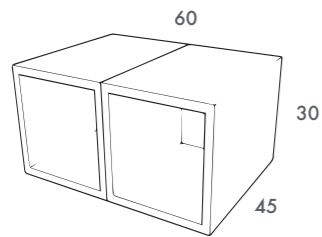

| CÓDIGO CODE | ANCHURA WIDTH |
|----------------|------------------|
| IMDB2360 | 60 |
| IMDB2370 | 70 |
| IMDB2380 | 80 |

ADMITE :
· LAMINADO · DECOMAT · FANTASIA · LACADO · CHAPA NATURAL.
ADMITTED :
· LAMINATE · DECOMAT · FANTASY · LACQUERED · NATURAL PLATE.

Mueble bajo de 60 · Base unit of 60

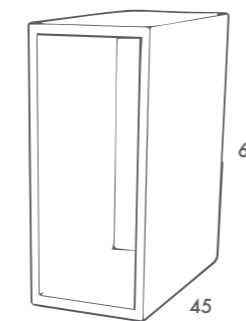

| CÓDIGO CODE | ANCHURA WIDTH |
|----------------|------------------|
| IMDB1620 | 20 |

ADMITE :
· LAMINADO · DECOMAT · FANTASIA · LACADO · CHAPA NATURAL.
ADMITTED :
· LAMINATE · DECOMAT · FANTASY · LACQUERED · NATURAL PLATE.

Mueble bajo de 90 · Base unit of 90

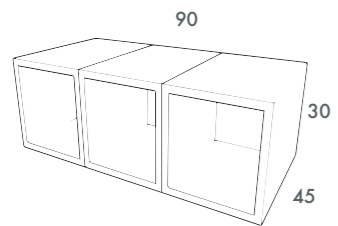

| CÓDIGO CODE | ANCHURA WIDTH |
|----------------|------------------|
| IMDB90 | 90 |

ADMITE :
· LAMINADO · DECOMAT · FANTASIA · LACADO · CHAPA NATURAL.
ADMITTED :
· LAMINATE · DECOMAT · FANTASY · LACQUERED · NATURAL PLATE.

Mueble bajo de 90 · Base unit of 90

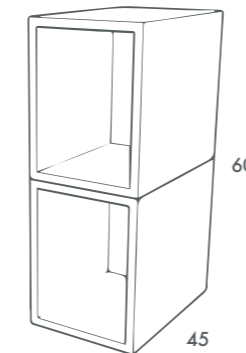

| CÓDIGO CODE | ANCHURA WIDTH |
|----------------|------------------|
| IMDB2620 | 20 |
| IMDB2630 | 30 |
| IMDB2640 | 40 |
| IMDB2650 | 50 |

ADMITE :
· LAMINADO · DECOMAT · FANTASIA · LACADO · CHAPA NATURAL.
ADMITTED :
· LAMINATE · DECOMAT · FANTASY · LACQUERED · NATURAL PLATE.

Medidas · Measures.

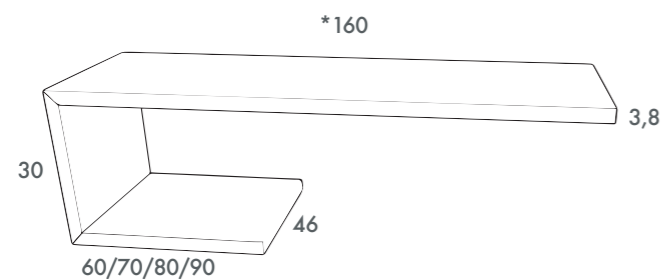

* Posibilidad de modificación de medida del tramo superior *1.60 cm.

* Possibility of modifying the measurement of the upper section *160 cm.

ACABADOS ADMITIDOS.

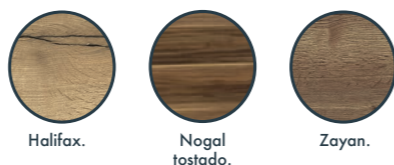

Encimera tipo "c" de 60 cm.
60 cm type "c" countertop.

| CÓDIGO CODE | ACABADOS FINISHES |
|----------------|----------------------|
| IMECN060 | NOGAL |
| IMECH060 | HALIFAX |
| IMECZ060 | ZAYAN |

Encimera tipo "c" de 70 cm.
70 cm type "c" countertop.

| CÓDIGO CODE | ACABADOS FINISHES |
|----------------|----------------------|
| IMECN070 | NOGAL |
| IMECH070 | HALIFAX |
| IMECZ070 | ZAYAN |

Encimera tipo "c" de 80 cm.
80 cm type "c" countertop.

| CÓDIGO CODE | ACABADOS FINISHES |
|----------------|----------------------|
| IMECN080 | NOGAL |
| IMECH080 | HALIFAX |
| IMECZ080 | ZAYAN |

Encimera tipo "c" de 90 cm.
90 cm type "c" countertop.

| CÓDIGO CODE | ACABADOS FINISHES |
|----------------|----------------------|
| IMECN090 | NOGAL |
| IMECH090 | HALIFAX |
| IMECZ090 | ZAYAN |

Juego de 2 patas metálicas acabado negro mate / Set of 2 metal legs, matt black finish

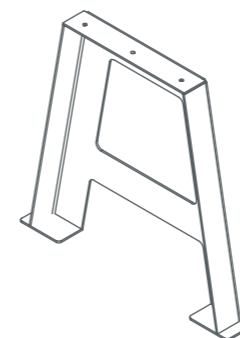

CÓDIGO
CODE

J2PATA43

J2PATA58

*ACCESORIO PARA MUEBLE MARKO LACADO Y MARKO MADERA.

ACCESSORY FOR MARKO LAQUERED FURNITURE AND MARKO WOOD

Juego de 4 patas de 12 cm de PVC acabado gris metálico / Set of 4 12 cm PVC legs with metallic gray finish

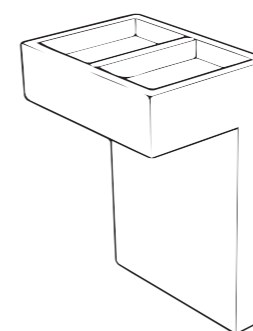

CÓDIGO
CODE

J4PATA12

Juego de 2 patas metálicas acabado según mueble / Set of 2 metal legs finished according to furniture

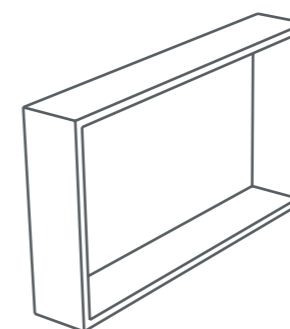

CÓDIGO
CODE

J2PATA25

*ACCESORIO PARA MUEBLE ALPE.

ACCESSORY FOR ALPE FURNITURE.

Juego de escuadras sujeción a pared / Set of wall fixing brackets

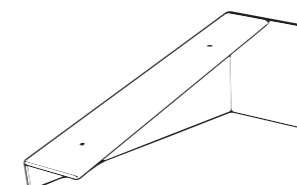

CÓDIGO
CODE

IMEJESP42



Medidas admitidas Admitted measures.

Anchura máxima admitida 200 cm.
Maximum width admitted 200 cm.

Profundidad 46 cm.
Depth 46 cm.

Grosos admitidos 12/19/22/38 mm.
Admitted thicknesses 12/19/22/38 mm.

| | ACABADO FINISHES | CÓDIGO CODE |
|---|----------------------------|----------------------|
| Tablero compacto. 1,2 cm de grosor. Compact board. 1.2cm thick. | BLANCO WITH NEGRO BLACK | TSMCMB12 TSMCMN12 |
| Tablero DE 1,9 cm de grosor. Board. 1,9 cm thick. | LACA LAQUERED | TSMLAC19 |
| | LAMINADO LAMINATED | TSMLAM19 |
| | CHAPA LOCK | TSMCHA19 |
| | DECOMAT DECOMAT | TSMDEC19 |
| | FANTASIA FANTASIE | TSMFANP19 |
| Tablero compacto. 2,2 cm de grosor. Compact board. 2,2cm thick. | LACA LAQUERED | TSMLAC22 |
| Tablero compacto. 3,8 cm de grosor. Compact board. 3,8cm thick. | LACA LAQUERED | TSMLAC38 |
| | LAMINADO LAMINATED | TSMLAM38 |
| | CHAPA LOCK | TSMCHA38 |



Medidas admitidas Admitted measures.

Anchura máxima admitida 200 cm.
Maximum width admitted 200 cm.

Profundidad 40 cm.
Depth 40 cm.

Grosos admitidos 38 mm.
Admitted thicknesses 38 mm.

| | ACABADO FINISHES | CÓDIGO CODE |
|---|-----------------------|----------------|
| Estantes con soporte oculto. Shelves with hidden support. | LACA LAQUERED | TSMLAC38 |
| | LAMINADO LAMINATED | TSMLAM38 |
| | CHAPA LOCK | TSMCHA38 |
| | MEDIDAS MEASURES | CÓDIGO CODE |
| Soportes ocultos para TSM 38. Hidden supports for TSM 38. | HASTA 60 CM. | SOPEST20 |
| | DE 61 / 120 CM. | SOPEST30 |
| | DE 121 / 200 CM. | SOPEST40 |



- Material resina con carga mineral · Resin material with mineral load
- Recubrimiento antibacteriano · Antibacterial coating

Acabados Finishes

Colores sólidos Solid colours.

Colores metálicos Metallic colours.



ENCIMERA SIN SENO DE 2CM COUNTERTOP WITHOUT SINK OF 2CM

| MEDIDAS MEASURES | CÓDIGO CODE | MEDIDAS MEASURES | CÓDIGO CODE |
|---------------------|----------------|---------------------|----------------|
| 61 | E20CF061 | 131 | E20CF068 |
| 71 | E20CF062 | 141 | E20CF069 |
| 81 | E20CF063 | 151 | E20CF070 |
| 91 | E20CF064 | 161 | E20CF071 |
| 101 | E20CF065 | 171 | E20CF072 |
| 111 | E20CF066 | 181 | E20CF073 |
| 121 | E20CF067 | 191 | E20CF074 |
| 131 | E20CF068 | 201 | E20CF075 |



Toallero ESCUADRA
SQUARE towel rail

DESCRIPCIÓN DESCRIPTION

- TOALLERO ESCUADRA CROMO BRILLO
· BRIGHT CHROME SQUARE TOWEL HOLDER
- TOALLERO ESCUADRA NEGRO
· BLACK SQUARE TOWEL HOLDER

CÓDIGO CODE

TOAL0ZNC
TOAL0ZNN



Toallero extraíble cromo brillo

Polished chrome pull-out towel rail

Para decorativo bajo de 60 con un hueco vertical

For decorative under 60 with a vertical hole



ORGANIZADOR MUEBLE 60

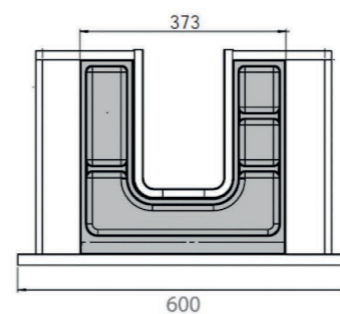

ORGSS060

ORGANIZADOR MUEBLE 70

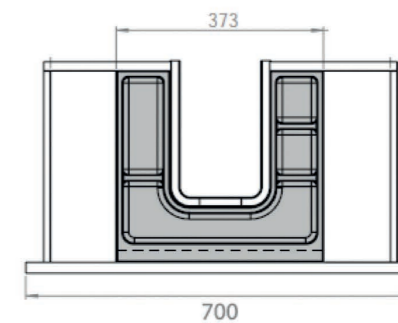

ORGSS070

ORGANIZADOR MUEBLE 80

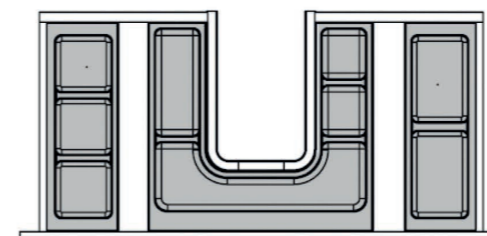

ORGSS080

ORGANIZADOR MUEBLE 90

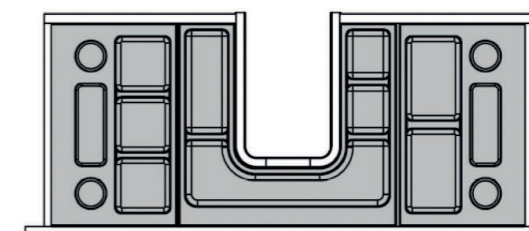

ORGSS090

ORGANIZADOR MUEBLE 100 Y 120

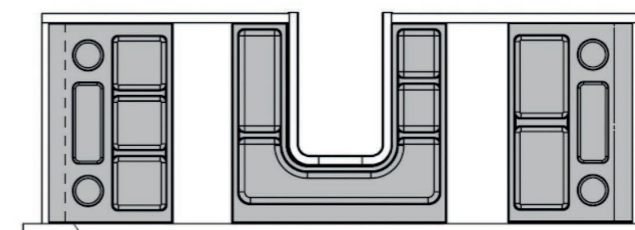

ORGSS100
ORGSS120

Nuestros Materiales · Our materials

Todos los materiales utilizados en la fabricación de nuestros muebles de baño son de alta calidad y de primeras marcas europeas que ofrecen todas las garantías para un perfecto funcionamiento.

All materials used in manufacturing our bathroom furniture are of high quality and leading European brands that offer all the guarantees for a perfect performance.

Colgadores · Hanging bracked

Colgador para mueble bajo CAMAR

Hecho totalmente de metal, en un grosor de tan sólo 10 mm ofrece una regulación horizontal de 19 mm y vertical de 22 mm y además tiene un sistema de anclaje que evita desacoplamiento accidental de la chapa de la pared.

CAMAR bracked for base cabinets

Made totally in metal, it has a thickness of only 10 mm, and offers an adjustment range of 19 mm in the horizontal and 22 mm in the vertical. It has a hooking system which prevents the cabinet from accidental falling from the wall.

Nuevo sistema antidescolgamiento

Una placa elástica evita el desacoplamiento accidental del mueble de la pared. El desacoplamiento voluntario es posible haciendo presión en con un destornillador.

New anti-drop system

A metal lip snaps into place to prevent accidental unlocking of the cabinet from the wall. The cabinet can be unlocked by simply pushing on the lip with a screwdriver.

CAMAR®
the art of innovation

Cajones · Drawer system

ArciTech

El sistema innovador ArciTech marca nuevas pautas en el cajón con su gran confort de deslizamiento y una extraordinaria estabilidad.

ArciTech

The Arcitech innovative system sets new standards in the drawer with sliding comfort and extraordinary stability.

Hettich

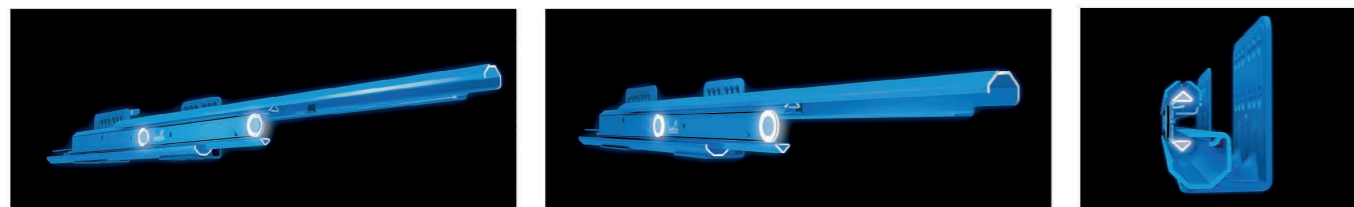

Bisagras · Hinges



SALICE

Bisagra SILENTIA serie 700

Bisagras con sistema decelerante integrado en la cazoleta. Bisagras para puertas de espesor mín. 16 mm. Profundidad de la cazoleta 13.5 mm. Abertura 110°.

Hinge SILENTIA serie 700

Hinges with integrated decelerating system into the bowl. Door Hinges thickness min. 16 mm. Depth of the bowl 13.5 mm. 110° opening.



Bisagra INTERMAT de montaje rápido

Ofrece considerables ventajas para el fabricante de muebles de baño, el montador y el usuario del mueble. Por ejemplo, la variedad de aplicaciones, su fácil y rápido montaje, su ajuste cómodo, su diseño agradable, su calidad inmejorable y su gran confort gracias al cierre silencioso.

Hinge INTERMAT quick assembly

It offers considerable advantages for the manufacturer of bathroom furniture, the installer and furniture user. For example, the variety of applications, its fast and easy assembly, comfortable fit, its nice design, excellent quality and great comfort thanks to quiet close.

Sistema apertura PUSH · PUSH opening system



EFFEGIBREVETTI

Clock

Sistema de apertura PUSH de gran calidad para puertas.

Clock

High quality PUSH open system for doors.



—Since 1979—